



*The TireRack*  
**BMW CCA**  
**Club Racing Series**  
**2026 RULES**



# **TIRE RACK**<sup>®</sup> .com



# Table of Contents

<b>I.</b>	<b>INTRODUCTION.....</b>	<b>1</b>
A.	CLUB PURPOSE.....	1
B.	INTENTION .....	1
C.	CAR CLASSIFICATIONS .....	1
D.	INTERPRETATION OF RULES .....	1
E.	RACERS ADVISORY COMMITTEE (RAC) .....	<b>ERROR! BOOKMARK NOT DEFINED.</b>
<b>II.</b>	<b>GENERAL RULES .....</b>	<b>3</b>
A.	PHILOSOPHY .....	3
B.	13/13 RULE OF VINTAGE RACING.....	3
C.	DRIVER ELIGIBILITY.....	3
D.	VEHICLE ELIGIBILITY, IDENTIFICATION, AND GENERAL REQUIREMENTS .....	4
<b>III.</b>	<b>SAFETY .....</b>	<b>8</b>
A.	TECHNICAL INSPECTION.....	8
B.	EQUIPMENT.....	10
C.	PASSENGERS .....	22
<b>IV.</b>	<b>RACING RULES.....</b>	<b>24</b>
A.	CHARACTERISTICS OF A RACE.....	24
B.	PIT STOP AND PIT LANE .....	29
C.	DRIVER CHANGE .....	30
D.	RAIN RACE .....	30
E.	ENDURO RULES .....	31
<b>V.</b>	<b>DRIVER CONDUCT: INCIDENTS, PENALTIES, APPEALS (AND PROTESTS).....</b>	<b>34</b>
A.	DRIVER CONDUCT: INCIDENTS, PENALTIES AND APPEALS .....	34
B.	PROTESTS.....	41
<b>VI.</b>	<b>RULES PROCESS.....</b>	<b>45</b>
A.	THE BMW CCA CLUB RACING RULES BOOK IS MAINTAINED ONLINE ON THE BMW CCA CLUB RACING WEB SITE. ....	45
B.	RULES CLARIFICATION .....	45
<b>VII.</b>	<b>CAR CLASSIFICATIONS .....</b>	<b>48</b>
A.	NON-BMW CCA CLUB RACING CLASSIFICATIONS .....	48
	<b>APPENDIX A: ROLL CAGE SPECIFICATIONS .....</b>	<b>79</b>
A.	GENERAL.....	79
	<b>APPENDIX B: HARNESS BELT SUPPLEMENTAL INFORMATION.....</b>	<b>83</b>
A.	APPROVED BELT CONFIGURATIONS .....	83
	<b>APPENDIX C: ELECTRICAL DISCONNECT SPECIFICATIONS .....</b>	<b>89</b>
	<b>APPENDIX D: VEHICLE CLASSIFICATION AND SPECIFICATIONS .....</b>	<b>90</b>
A.	SPORT AND PREPARED .....	90
	<b>APPENDIX E: FLAGS, SIGNALS, AND COMMUNICATION .....</b>	<b>96</b>
A.	PURPOSE AND METHODS .....	96

**APPENDIX F: NORTH AMERICAN POINTS SYSTEM..... 103**  
A. INTRODUCTION.....103  
**APPENDIX G: DYNO TESTING ..... 110**  
**APPENDIX H: RACING GLOSSARY ..... 111**

Quarterly Color Codes:

- 2026 Updates

## I. INTRODUCTION

### A. Club Purpose

BMW CCA Club Racing offers all BMW CCA licensed club racers a competitive driving experience conducted in a fun, safe, and friendly environment on a reasonably level, class-based playing field for all types of factory authorized or constructed BMWs. The primary emphasis is on clean driving and machinery preservation. The application of common rules and procedures by the BMW CCA Club Racing stewards at each event maintains this philosophy.

### B. Intention

These rules are intended to be simple, easy to read, and brief. The rules assume all modifications or alterations to the stock car, as available by BMW in the United States through its authorized dealer network, are prohibited unless specifically stated herein as being allowed. All competitors are expected to conform to the stated philosophy and rules, and to embrace the spirit of BMW CCA Club Racing. That spirit is founded in the belief that the fun of the friendly competition is more important than the results and that mutual assistance among racers when possible, enhances the experience for all.

### C. Car Classifications

1. The **Sport** classes are for race cars with specified modifications to provide an entry point for club racers. All other modifications to the vehicle are for safety purposes only.
2. The **Prepared** classes allow participation with a higher level of modification than the Sport classes and remain in keeping with the spirit of the "original" vehicle. All Sport class improvements are also allowed in the prepared classes. All Prepared class improvements are also allowed in the Modified classes
3. The **Modified** classes are for race cars with a still higher level of modification than the Prepared Classes.
  - a. Requires a BMW engine
  - b. Requires a BMW transmission
4. The **SpecE36™** class is for the racer who desires an "even playing field" with a tightly specified level of preparation and performance. The modifications required or allowed produce a fun, fast race car that feels like a race car, yet remains relatively inexpensive to prepare and maintain.
  - a. E36 chassis
  - b. Six-cylinder race cars prepared to a uniform level
  - c. Required or mandatory suspension and tire components

### D. Interpretation of Rules

1. If differing interpretations are possible, a specific rule prevails over a general rule. For example, if a rule states, "no changes giving a competitive advantage may be made" (general rule) versus "Accusumps are permitted" (specific rule), the specific rule prevails over the general rule even though some may argue that Accusumps give a competitive advantage.
2. No rule Exists in a Vacuum
  - a. Read each rule in the context of all rules. If there are two possible interpretations to a rule, and one interpretation conflicts with another rule or makes another rule meaningless, that interpretation will be rejected in favor of an interpretation that is not in conflict with any other rule or makes another rule meaningless.
  - b. Each rule must be read in its entirety. An interpretation of a part of a rule that conflicts with another part of the rule or makes another part of the rule meaningless will be rejected in favor of an interpretation that gives meaning to and does not conflict with other parts of the rule.

BMW CCA Club Racing Rules 2026 – 1/30/2026

E. The Racers Advisory Committee has been eliminated.

## II. GENERAL RULES

### A. Philosophy

The BMW CCA Club Racing program provides a fun, safe, and competitive venue for its members. Good sportsmanship, honesty, and fair play must exist at all BMW CCA Club Racing events. Conduct that jeopardizes safety or results in dangerous or damaging situations will not be tolerated.

Transactions or arrangements that might benefit the private interest of an official, steward or race participant are prohibited.

### B. 13/13 Rule of Vintage Racing

1. In BMW CCA Club Racing, racers that violate the rules or cause incidents through driver error will be:

a. Given a probation penalty for a prescribed number of Club Racing Events (1 CR Event = 1 weekend), or given a suspension penalty of 6-13 months if already on probation penalty, depending on the egregiousness of the rule violation.

b. Additionally, a suspension may be recommended by a Competition Steward if an incident is the result of an egregious action, if the racer is currently on probation or if a racer exhibits extreme behavior of unsportsmanlike conduct. A recommendation of a suspension will be forwarded to the National Competition Steward for National Review and final determination. This review may focus solely on the incident, but may also consider current license status, prior history and penalties assessed and any special circumstances that may be relevant to the decision.

### C. Driver Eligibility

1. Only BMW CCA Club Racing Program licensed drivers are eligible to compete in BMW CCA Club Racing events.

a. A club racing license (and associated medical approval) that is valid at the beginning of a race event will remain valid through the duration of that event regardless of expiration date.

2. Alcohol and Drugs

a. No driver may participate in any on-track activity within an event while under the influence of a substance, prescriptive or otherwise, including alcohol, which has the potential to negatively affect the driver's performance.

b. Consumption of alcohol is strictly prohibited by any racer, member of a racer's crew, racer's guests, event volunteers, or event staff until such time as the last car in the day's last run group or session is off the track.

3. Pregnancy Policy

The BMW CCA Club Racing Medical Committee has determined that driving race cars while pregnant poses many risks to unborn children. During the first trimester, the risks for injury to the child from x-rays possibly needed to stabilize an injured driver can result in birth defects. After the first trimester the potential for placental injury in a non-life-threatening crash is high.

a. BMW CCA Club Racing does not recommend racing while pregnant, and BMW CCA Club Racing expressly prohibits racing after the first trimester.

b. Female racers who are pregnant or suspect they may be pregnant are encouraged to seek medical advice from their physician regarding their participation in BMW CCA Club Racing.

- c. The racer is required to notify the National Licensing Coordinator that she is pregnant as soon as practically possible after such determination by submitting the following:
  - i. A statement from the attending physician that establishes the end of the first trimester
  - ii. Note the pregnancy on her event Medical Information form, which is a required part of each entry application
- d. Sign an acknowledgement of this policy and a waiver of liability and return them to the National Licensing Coordinator
- 4. Medical Condition Affecting Fitness of Driver
  - a. Personal Medical Information
    - i. BMW CCA Club Racing recommends use of personal medical information to be worn by all drivers.
    - ii. Drivers with diabetes or who are undergoing medically directed anti-coagulant treatment must do one of the following:
      - 1) Attach a Medical Carrier Information or equivalent pouch attached to his or her helmet
      - 2) Label his or her helmet indicating “diabetic” or “anti-coagulant.”
  - b. Any new medical condition (including pregnancy) since the last licensing exam that could affect a racer’s medical fitness to compete must be reported immediately to the BMW CCA Club Racing Medical Committee for review.
- c. The driver may not compete until recertified by the BMW CCA Club Racing Medical Committee.

#### D. Vehicle Eligibility, Identification, and General Requirements

##### 1. Types of Cars

- a. BMW-manufactured automobiles, using BMW-manufactured chassis, engine case, and transmission case. Engine and transmission must have been factory designated for automotive application.
- b. BMW factory-built chassis with cages (commonly referred to as a Motorsport chassis) eligible in Modified and PWR. These chassis do not require a vehicle identification number (VIN). Chassis without U.S. VINs are also allowed.
- c. BMW jointly developed Toyota Supra (J29/DB) models produced in Austria from 2020 to 2025 in with either the B59 or B48 engines are allowed. Similar to other BMW turbo powered cars, the Supra is allowed in Sport, Modified and PWR classes.
- d. Factory-approved race cars are eligible. Documentation of factory approval is the responsibility of the car owner.
- e. Purpose-built, BMW-powered race cars specifically approved by BMW CCA Club Racing.
- f. Open-wheel cars are not eligible.

##### 2. Classification

###### a. Class Declaration

- i. An entrant’s application to participate in an event is a statement that the car is in compliance with all rules applicable to its declared class.
- ii. The racer assumes final responsibility for properly declaring the class of the car.
- iii. All cars must be entered in their appropriate class.

BMW CCA Club Racing Rules 2026 – 1/30/2026

- iv. Cars may not enter a higher class unless their configuration warrants the classification.

For example, a car eligible for D Modified may not run under C Modified, and any Prepared class car may not run under the Modified class unless it contains modifications not allowed in the Prepared class.

b. Dual Classification

- i. A car may be classified in both a native club racing class (Sport, Prepared, Modified or Spec X) and a PWR class. Only in this case may a car change class declaration just prior to the start of a race weekend. A car registered in a native class may request a change of class prior to the start of the first timed session (Qualifying or Race) given the following conditions are met:
  1. All PWR class requirements are submitted and approved (2 weeks) ahead of the race weekend. This includes valid Dyno Test documentation and an official approved PWR Class Disclosure Sheet.

c. Award Eligibility

Vehicles must compete in the class to which they are correctly classified and run in at least one session to be eligible for awards.

3. Identification Decals

a. Car Number and Class Identification

- i. Competitors may request assigned numbers from the National Timing and Scoring Steward.
- 3) Every attempt will be made to give a competitor the requested number if it is not already assigned.
  - 4) Where duplications at an event exist (due to grandfathered duplicate numbers or numbers on cars that are also running in non-BMW CCA Club Racing series), deference will be given to the racer with the lowest BMW CCA Club Racing license number.
  - 5) Race officials reserve the right to assign car numbers for specific events.
    - ii. All cars must display easily readable numbers and class identification that are of significant size and color differentiation from the background color so event officials can clearly see them.
    - iii. Numbers must appear on each side, the hood, and rear of the vehicle.
    - iv. Additional car numbers must be on the front windshield in the lower position, passenger side. These numbers must be white and at least 4 inches tall. This requirement will be enforced starting in 2026.

v. Number Sizes

Placement	Height	Stroke
Side	8 inches	1.5-2 inches
Hood	8 inches	1.5-2 inches
Rear	3 inches	0.5-1 inch

vi. Class Identification Sizes

- 1) Class identification must be near the car number on the sides, hood, and rear of the vehicle.
- 2) Class identification must be at least 3 inches high.
- 3) Class identification is normally two letters, except as noted in the following table:

<b>Classification</b>	<b>Abbreviation</b>
A Modified	AM
I Prepared	IP
J Sport	JS
Spec E36	SE36
Spec E46	SE46
E30 M3 Touring	M3T
M2 Spec	M2CS
M240 iR Spec	M240

4. Series and Sponsor Identification

- a. Club Racing officials may require series and sponsor identification (decals) in specific size, contrast, and placement to be displayed on cars before being allowed on track. The “General Information-for the racer” section on the web site specify size, contract, and placement.
- b. Alternate sponsor decals, other than those provided through BMW CCA Club Racing, may be used with the specific agreement of the sponsor. It is the racer's responsibility to obtain the sponsor's agreement and have such documentation available at each event.

5. Rookie Identification

Vehicles driven by license holders with a license status of Rookie must display the rookie decal, yellow circled "X", at the rear of the car.

6. All vehicles with a declared class under another sanctioning body's rules may have markings as specified by the applicable sanctioning body rules rather than those specified herein. These vehicles are required to display the TireRack windshield banner across the top of the windshield.
  - a. TireRack banner must be the official windshield banner provided by Tire Rack sourced through BMW Club Racing or an approved equivalent sized TireRack banner (must be approved by the CR rules committee).
  - b. No other decals or logos are allowed on the windshield with the exception of event tech stickers and the driver's name/car number. The driver's name, if utilized, must be located in the lower right hand (passenger) portion as well as the car number.

7. All other sponsor decals must be placed on the car and visible as required.

8. Vehicle Appearance

- a. Vehicles entered in the program must, in addition to meeting safety and classification rules and regulations, be presented in an attractive and eye-pleasing manner.
- b. BMW CCA Club Racing Stewards reserve the right to refuse entry to any vehicle that they feel does not “conform to the spirit” of the BMW CCA Club Racing Program.

9. General Requirements

- a. Tow Points

- i. All race cars must be equipped with front and rear tow points with a minimum diameter of 2 inches.
    - 1) Must not protrude dangerously from the bodywork
    - 2) Must be easily accessible without removal or manipulation of bodywork or other panels
    - 3) Capable of sustaining the stresses of towing
  - ii. Recommended Styles
    - 1) Webbed nylon strap
    - 2) Folding hook
- b. Timing Transponders
  - i. AMB transponders are required and must be turned on and functioning properly for all on-track sessions.
  - ii. The Timing and Scoring Steward may black flag any car on track without an active AMB transponder.
  - iii. The Competition Steward may choose to further penalize any driver who fails to activate their transponder after the first warning.

### III. SAFETY

The following safety regulations apply to all cars in all classes. If you are in doubt as to an interpretation, ask, and always go on the side of being overly safe.

#### A. Technical Inspection

1. Event officials use technical inspection to determine, in their judgment, eligibility of a vehicle for participation in a BMW CCA Club Racing sanctioned event.
  - a. The technical inspection does not ensure, certify, or warrant that the vehicle or any part thereof is safe or totally and ultimately compliant with all applicable rules.
  - b. The technical inspection does not in any way change the fact that the driver, the crew members, and the vehicle owner are ultimately responsible for the safety and operation of the vehicle and equipment.
  - c. The participant agrees responsibility of the following:
    - i. To ensure the safety of the participant's vehicle, equipment, and clothing and compliance with all BMW CCA Club Racing rules, regulations, and agreements, including but not limited to those contained in this rulebook
    - ii. In the case of technical violations, acknowledgement, understanding, and agreement with full knowledge of every component of participant's vehicle, even if a third party (for example, an engine builder) has caused the participant's vehicle to be noncompliant
    - iii. Any applicable violation or penalty
2. Annual Technical and Safety Inspection
  - a. All race cars in a BMW CCA sanctioned race must undergo a comprehensive annual technical and safety inspection within the past 365 days (Annual Period) **before** participating in any BMW CCA Club Racing event. BMW CCA Club Racing staff are not authorized to perform the Annual Technical and Safety Inspection.
  - b. Any race car crossing over from another organization will be allowed, for 1 race event, to substitute an equivalent valid annual technical inspection from the original organization. Subsequent/continued racing with BMW CCA Club Racing requires an official Club Racing Annual Technical and Safety Inspection as described in this section. Following the Club Racing Annual Tech inspection, a Club Racing Logbook will be issued by a Club Racing Tech Steward.
  - c. A Qualified BMW CCA Club Racing Inspection Shop must perform a proper Annual Technical and Safety Inspection before participating in an event.
  - d. The car owner must complete the Annual Technical and Safety Inspection form, found on the BMW CCA Club Racing website, and validate it with their signature before the shop perform the Annual Technical and Safety Inspection.
  - e. The car owner must present the following to the Qualified BMW CCA Club Racing Inspection Shop inspector:
    - i. Annual Technical and Safety Inspection form
    - ii. Logbook (not required for a new build car or an initial crossover from another race organization)
    - iii. Driver safety gear
    - iv. Vehicle
  - f. Following the successful completion of the inspection:

- i. The inspector must sign the form must and staple it to the logbook.
  - ii. The entrant must present the logbook to the Steward at each event for the remainder of the annual period.
- g. The BMW CCA Club Racing website lists all Qualified BMW CCA Club Racing Inspection Shops.
  - i. BMW CCA Club Racing may designate additional qualified inspection shops and will publish such inspection shops on the BMW CCA Club Racing website.
  - ii. The fitness of the vehicle for competition is the responsibility of the entrant. If significant modifications or accident repairs are made to the vehicle, a new annual inspection must be performed.

### 3. Event Tech

- a. All cars must be comprehensively prepared prior to arrival at the track.
- b. If the race car has completed a current season annual technical and personal equipment inspection, and the form is stapled to the race car's logbook, the racer must present only the current logbook and all required personal safety gear to the event Technical Steward.
  - i. The race car does not need to be presented unless there is an outstanding discrepancy noted from in the logbook from the prior event, or if the Technical Steward requires it.
  - ii. The Technical Steward may ask for the race car to be presented for inspection at any time during the event.
- c. Any vehicle deemed unsafe by BMW CCA Club Racing Stewards will not be allowed on track until all deficiencies have been addressed to the Stewards' satisfaction.
- d. Equipment and vehicle modifications will not be considered as having been approved by reason of having passed through inspection unobserved or uncommented upon.
- e. Any driver who fails to present his or her race car for a required or requested technical inspection will be immediately disqualified for all applicable sessions and for the remainder of the event.
  - i. The driver will be placed on a mandatory 13-month probation.
  - ii. The racer may be suspended for 13 months if both the Technical Steward and the Competition Steward agree that circumstances warrant such action.

### 4. Tech Inspection for Rules Compliance

- a. Tech Stewards may require an onsite, detailed tech inspection for rules compliance at any time during an event, including weighing any car or a detailed tech inspection of entries in a specific class or classes at a race.
- b. Tech Stewards may request disassembly and/or inspection of any entered car to ascertain its compliance with these rules.
  - i. If the car is in compliance, BMW CCA Club Racing shall pay the expense of disassembly, inspection, and reassembly.
  - ii. If the car is not in compliance, the competitor must bear these expenses.

### 5. Unlisted Modification

- a. Any modification, adjustment, alteration of stock items, and/or installation of equipment or part(s) not specifically and purposefully listed is **not** allowed. If the rules do not state you can make a modification, do not make the modification.
- b. Drivers assume ultimate responsibility for their race car's conformance to all rules, regulations, and specifications even if they did not perform the work themselves.

- c. Every driver is responsible to ensure that all work done and all parts installed on his or her race car are accomplished in a manner that ensures conformance with all applicable rules.

**B. Equipment**

**1. Driving Apparel**

- a. A driver is required to wear a suit that covers his or her entire body except for hands, feet, and head.
- b. Rating
  - i. SFI 3.2A/1 or higher (3.2A/5, 3.2A/10, 3.2A/15, or 3.2A/20 or 3.4A)

**Note:** SFI 3.2A/1 suits must be worn in conjunction with full length upper and lower fire-rated underwear.

- ii. FIA 8856-2000, FIA NORME 1986/1986, or FIA 8856-1986 or FIA 8856-2018

**c. Underwear**

- i. Regardless of the number of layers of a suit, fire retardant NOMEX® or Carbon-X underwear is strongly recommended.
- ii. Any underwear including t-shirts, boxers, and socks should be fire-rated material.
- iii. Cotton underwear is not recommended as it does not wick away the moisture and can result in serious steam burns in the event of a fire.

**d. Socks, gloves, and shoes**

- i. Fire-retardant socks and gloves are required.
- ii. Driving shoes of a fire-retardant material are required.

**e. Balaclava**

Drivers with mustaches and/or beards must wear a fire-retardant balaclava.

**2. Helmets**

**a. Helmet Ratings**

Organization	Type	Rating
Snell Foundation Special Application (automotive)	All	SA-2020 or newer (SA-2015 will be allowed until the end of 2026)
SFI	Open-faced	31.1a
	Closed-faced purchased before 12/31/2014	31.2a
	Closed-faced purchased after 1/1/2015	31.1
FIA	All	8859/8860

- b. Snell **M**-rated helmets are **not** allowed.

**c. Full-face Helmets**

- i. Drivers of vehicles without full windshields are required to have either a full-face helmet with shield in place or use protective goggles.

- ii. It is recommended that all drivers wear either a full-face helmet with the shield in place or protective goggles.
    - iii. If a helmet's face shield is not used by a racer to meet the eye protection requirements, then removing it from the helmet is recommended.
  - d. Any helmet exhibiting visible cracks must be replaced. In the event of a significant impact with the ground (dropping the helmet by accident) or contact with the roll cage, the helmet must be replaced.
  - e. Eject Helmet Removal Systems

Permitted and recommended to assist emergency medical personnel to remove an injured driver's helmet with reduced chance of injury to the neck or cervical spine.

### 3. Head and neck Restraints

- a. All racers must use a head and neck restraint system meeting the standard of SFI 38.1 or FIA 8858-2002.
  - i. The SFI website, <http://www.sfifoundation.com/manuf.html#38.1>, describes the SFI 38.1 standard.
  - ii. The FIA website, [https://www.fia.com/sites/default/files/regulation/file/3\\_FIA\\_Stand\\_8858\\_2002\\_Hans\\_0.pdf](https://www.fia.com/sites/default/files/regulation/file/3_FIA_Stand_8858_2002_Hans_0.pdf), describes the FIA 8858-2002 standard.
- b. HANS Device
  - i. The harness shoulder belt webbing must be in direct contact with the yoke of the HANS.
  - ii. Padding between the shoulder harness webbing the yoke of the HANS is prohibited.
  - iii. Sternum straps are not allowed for use with the HANS due to possible interference issues.
  - iv. HANS-specific 2-inch hybrid shoulder straps may be used in conjunction with this system providing they meet harness certifications from FIA, SFI 16.1, or SFI 16.5.
  - v. Any HANS device must have the following stickers:
    - 1) Silver and blue SFI 38.1 sticker, which is punched with the month and year, and/or
    - 2) Silver and black FIA 8858-2002 sticker
      - a. Head and neck restraint devices that carry a silver and black FIA 8858-2002 sticker (regardless of SFI sticker) must have the tethers replaced 5 years after the date of manufacture and requires no other recertification unless damaged (see below).
      - b. Any head and neck restraint system must be inspected after a serious incident. If any cracking, delaminating or elongation has occurred, the unit must be replaced.

#### 1) SFI 38.1

- a) Any devices approved under SFI 38.1 will be deemed to be automatically added to the list of approved devices for BMW CCA Club Racing.
  - b) Must be inspected and recertified every 5 years from the date of manufacture as punched on the label.
  - c) Must be inspected and recertified by the original manufacturer.
    - i) If acceptable for continued use, the original manufacturer will affix a new SFI 38.1 conformance label marked with the inspection date, which validates the HANS device for another 5 years.
- 2) Devices that meet or claim to meet SFI or FIA specifications but do not actually carry an SFI or FIA certification sticker are not approved.
4. Driver Comfort Systems
- a. Driver comfort systems, such as chilled water systems and air ducting with or without fans and/or filters, may be added to any car provided they do not violate any other specific rule.
  - b. All driver cooling systems must be securely mounted to the chassis or roll cage.
  - c. Components not bolted, such as water or ice containers, must be secured by safety straps.
5. Roll Cages
- a. All classes require a full roll cage.
    - i. A diagonal brace is required in the rear hoop.
    - ii. All cages must be mounted metal-to-metal, of approved materials and of proper size as listed in Appendix A.
    - iii. Side impact “door bars” may be added to any cage; the driver's side and passenger side door and door panels may be modified or removed to accommodate them.
    - iv. Bolt-in cages are not permitted in race cars that were issued logbooks after 1/1/2007.
  - b. The top of the driver’s helmet, when the driver is properly attired and seated, must have a two-inch clearance below the plane created between the top of the front and main roll hoops if the vehicle is participating without a roof or hard top solidly affixed.
  - c. Specific Class Roll Cages
    - i. Sport/Prepared/SpecE36/E30 M3 Touring
      - 1) Roll cage must be as follows:
        - a) Bolted or welded into the car,
        - b) Contained entirely within the driver/passenger compartment, and
        - c) Include six attachment points as shown in Appendix A.
      - 2) A maximum of two additional bars may be extended from each front roll cage hoop down bar to the front wheel well (two on each side) to protect the occupant’s feet and legs. The two-foot protection bars on each side must use the same mounting point on the wheel well.
      - 3) Attachment points must be metal to metal.
      - 4) Main hoop rear braces may be mounted to the frame or chassis (rear shock mounts, shock towers or accessible frame rails). Such rear braces may pass through any rear bulkhead or panel separating the driver/passenger compartment from the trunk/cargo

area/fuel tank/fuel cell area, provided the bulkhead or panel is sealed around said cage braces.

- 5) Cage tubing cannot be welded or bolted to the sides or roof.
  - 6) A maximum of two additional bars may be extended down from Roll Cage door bar and protrude through the sheet metal floor for the sole purpose of an additional lifting location (or "Jack Point") of the vehicle. These points must not be attached to plates, the vehicle frame, or any significant structural component of vehicle. The two Jack Point bars, one on each side of the vehicle, must use the same mounting point on each side.
- d. Modified and PWR Classes.
- 1) Cage construction is free provided it complies with the basic structure outlined in Appendix A.
  - 2) The cage attach points and number of attach points are free.
- e. Rollbar Padding (all classes)
- i. Half-round SFI 45.1 or FIA 8857-2001 Type A, high-density roll bar padding is required to cover any tubular element of the roll cage that may possibly contact the head and, in particular, any bar that is within 12 inches of the head.
  - ii. Padding must be secured with zip-ties, duct tape, high-strength adhesive, or a combination thereof.
  - iii. Low-density, soft-tubular padding can be used in other areas such as door bars and shin bars but may not be used in any potential head contact area.
6. Air Bags and Steering Wheel
- a. Non-stock steering wheels are allowed in all classes.
  - b. Airbags may be disconnected during on-track sessions in all classes and may be removed from the stock steering wheel.
  - c. Steering wheel locks must be removed or disabled.
7. Floor Mats
- a. Must be removed.
  - b. Driver side carpet and associated underlying interior insulation materials may be removed.
  - c. Carpet is not required to be OE.
8. Seats and Seat Back Braces
- a. Homologated seats
    - i. FIA 8855-1999 or higher
      - 1) Do not need to have a seat back attached to the roll structure.
      - 2) Homologation label must be visible
      - 3) Seat supports must be the type listed on FIA technical list No. 12 (lateral, bottom, and so forth).
    - ii. Expired FIA certification (over 5 years) or no certification evident require seat back bracing, even if the back of the seat is close to the horizontal roll cage tube.
  - b. Seats
    - i. A one-piece bucket-type racing-style seat is required for the driver.

- b. Aluminum seats must be sized to the driver, in fit and in strength, based on the weight of the driver. The seat manufacturer should be consulted before use if the weight of the driver exceeds 200 pounds. "Rib-protector" options on these seats are not recommended. Aluminum seat technology is rapidly changing. Please consult the National Safety Steward with specific questions to the appropriateness of any aluminum seat.
  - i. If a circle-track aluminum seat is used, it must be mounted to a minimum of two points at the bottom front, two points at the bottom rear, and at should height to a bar traversing the main center hoop preferably with a mounting structure across the entire back of the seat (L type mount).
    - 1) Must be sized for fit and strength of the driver, based on driver's weight.
    - 2) Consult the seat manufacturer if the driver's weight exceeds 200 pounds.
    - 3) Rib-protector options are not recommended.
    - 4) Consult the National Safety Steward with specific questions to the appropriateness of any aluminum seat.
- c. Seat Back Braces
  - i. If required, seat back bracing must be attached to the horizontal tube on the main hoop of the cage.
  - ii. Braces must either be:
    - 1) Bolted securely to the seat using a metal plate of no less than 12 square inches to distribute the load, **OR**
    - 2) A brace of similar minimum dimensions must be in contact with the seat back.
      - iii. Minimal energy absorbing padding is allowed between the brace and seat back.
      - iv. If the brace is not attached to the seat, the brace should, where possible, wrap around both sides of the seat to prevent lateral movement.
      - v. Contact your Regional Technical Steward with any specific application questions.
- d. Hardware
  - i. The minimum diameter of all seat-fastening hardware must be 8 mm.
  - ii. 2002s, 530i's and early 320i's must upgrade the original 6 mm hardware.
  - iii. It is strongly recommended that the seat mounting pads on these early cars be strengthened to withstand the loads of racing.
- e. Headrests
  - i. Headrests, either integral with the seat or separate, are required.
  - ii. The headrest must extend above the midpoint of the back of the helmet on the vertical plane of the seatback with the driver in the normal seating position.

9. Safety Harnesses

- a. All drivers in BMW CCA Club Racing events must use a 6- or 7-point harness meeting SFI 16.1 , SFI 16.5, or FIA 8853 standards, with the following measurements:

Belt	Measurement (inches)
Lap	2-3 inches

Anti-sub strap	2 inches
Shoulder straps	2 inches (with HANS only)
	3 inches (no HANS)

**Note:** Sternum straps are not recommended and are not permitted with the HANS device.

- b. Properly certified harnesses meeting the above specifications are required at all times during practice, qualifying, and race sessions and must have the appropriate SFI or FIA tags as proof of certification
- c. Harness Certification
  - i. SFI Certifications
    - 1) 16.1 and 16.5 expire two years after the date of manufacture at the end of the manufactured month. For example, a harness tagged with a manufacturing date of April 2018 expires on April 30, 2020.
    - 2) SFI tagged harnesses are punch with the month and year of manufacture and are labeled in three places:
      - a) Shoulder belt
      - b) Lap belt
      - c) Sub-strap



- ii. FIA Certifications
  - 1) FIA certifications expire on December 31<sup>st</sup> five years after the date of manufacture. The tag or stamp is the year of expiration. For example, a harness manufactured in 2016, is tagged or stamped with the expiration year 2021 and, therefore, expires on December 31, 2021.
  - 2) FIA certified harnesses have tags printed by the manufacturer and are located on each of the harness components:
    - d) Shoulder belt
    - e) Lap belt
    - f) Sub-strap
  - iii. Harnesses without certification are prohibited.
  - iv. Harness configuration and installation

Refer to Appendix B for approved harness configuration and installation standards.

- v. Belt Replacement
  - 1) Regardless of the date of manufacture, the safety harness must be replaced if the webbing is cut or frayed, significantly faded, or if the webbing has any visible damage to the surface.

- 2) The safety harness must also be replaced if any of the buckles are bent or cracked, or if the car has been in a severe impact.
- 3) If any of these conditions exist, the Tech Steward will cut the certification labels off the harness.
  - vi. Belt thickness
    - 1) Two-inch lap belts are strongly recommended. Two-inch lap belts have been shown to provide faster loading of the lap belt resulting in lower loads to the chest, head, and neck. The fit around the pelvis is better allowing the belt to be worn tighter while being more comfortable and easier to adjust. The smaller adjusters are less likely to get caught up in the small lap belt holes provided in most seats.
    - 2) Two-inch lap belts are currently only available with FIA certified harnesses.

## 10. Camera Mounts

- a. Cameras and camcorders must use the following to mount and secure the device:
  - i. At least one bolt
  - ii. Strap or tether
    - 1) Must be made of high-tensile webbing or steel.
    - 2) Must be short enough to prevent the camera from reaching any part of the driver.
- b. These rules of attachment do not apply to “lipstick” or “bullet” cameras that serve as remote lenses for a separate recording device. These lenses may be secured using items such as cable ties and racer tape.

## 11. Rear Bulkhead

- a. A sealed metal bulkhead between the passenger compartment and the compartment containing the fuel tank is required on cars using the following:
  - i. Fuel cell
  - ii. The fuel tank is not totally under the car floor (for example, it is required in 1600/2002 models).
- b. A bulkhead is highly recommended on cars where the fuel tank is under the body (for example, all E36 models).

## 12. Ballast

- a. Placement of any ballast to meet weight:
  - i. Entirely in the front and/or rear passenger side floor area, and/or
  - ii. Spare tire well in the trunk
- b. Must be securely bolted to the chassis.
- c. Each segment of ballast must weigh not more than 50 pounds.
- d. Must be fastened with a minimum of two 12 mm bolts and positive lock nuts of metric grade 8.8 or better, and must utilize large diameter, load-distributing washers.
- e. Ballast may not be added or removed during any officially timed session.

## 13. Fire Safety

- a. On-board fire systems are required for all cars.
- b. Minimum of two nozzle locations: One in the driver's compartment and one in either the engine area or the fuel cell area.

- c. All fire suppressions systems must be certified SFI 17.1 or FIA homologated as FIA Technical List 16. FIA Technical list 52.
- i. The certification is valid for 2 years as designated by the applied certification decal.
  - ii. Fire bottle must be re-certified every 2 years by the manufacturer or designated agent.
  - iii. The bottles must be positioned so that the Tech Steward can clearly read the manufacturer's label, certification tag and pressure gauge (where applicable).
  - iv. A red and white circle "E" decal must be placed adjacent to any activation button or pull-handle to identify the activation point of all onboard fire systems.



v. Activation

1. Manual, electric, or automatic activation is allowed.
2. Manual or electric release activation mechanisms must be within reach of the driver when belted in the car.
3. Mechanical firing safety pin(s) must be removed from, and electrical control boxes must be switched on for all on-board fire systems prior to going on track.

14. Arm Restraints

Open cars, including convertibles with installed hardtop, must be equipped with approved arm restraints.

15. Windows

a. Windshield

- i. Windshield retention clips are allowed and encouraged in all classes.
- ii. Impairments - Any of the following require the repair or replacement of the windshield
  - 1) No more than three distinct and different cracks exceeding 20 inches combined length
  - 2) No single visible round imperfection that is larger than 1.5 inches in any dimension
  - 3) No single crack that runs from opposite edges (side to side or top to bottom)
  - 4) No single crack that is through both the inside and outside surfaces at any point
  - 5) No impairment to the racer's forward vision from either external or internal imperfections in the glass, including "sandblasting" effect.

If such items are found to exist, the Technical Steward may issue a one-time exception in the race car's logbook requiring replacement by the next event so long as, in the Steward's sole judgment, the structural integrity of the windshield is not immediately compromised, and the driver's vision is not dangerously impaired.

b. Rear Window Tint

- i. Tinted rear windows are specifically disallowed in all classes and the use of tinting is discouraged in all windows.
- ii. Original equipment (OE) window tinting is allowed.
- iii. The purpose of this rule is to address dark aftermarket tinting that causes safety issues in driver awareness and communication.

c. Rear side windows may be utilized for various decals (driver name, modifiers, etc.) but under no circumstances should the decals or any other window covering material completely block visibility through the window.

d. Sunroofs must remain completely closed.

16. Window Nets

a. Expiration

- i. SFI window nets expire 2 years after the date of manufacture at the end of the month of manufacture as indicated on the label.
- ii. FIA 8863-2013 window nets expire 5 years from the year of manufacture on December 31<sup>st</sup> of the year printed on the net(s).
- iii. Window nets without a certification label shall be considered as expired and must be replaced.

1) Both front door windows must be completely down and an approved window net and attachment system fitted to the driver's window area with the exception of e) below.

a) The window net must be attached to the cage and **not** to the door.

b) Holes must not be drilled in the cage to mount the window net.

c) The use of plastic tie wraps (zip-ties) is not allowed for mounting.

d) Straps may be used providing they are part of the installation kit provided by the manufacturer of a certified net.

e) Factory delivered race cars that were FIA homologated to race with windows in the up position, are permitted to do so.

2) All window nets must cover the window opening such that a driver's hand or arm cannot extend outside the vertical plane between the a- and b-pillars and be SFI 27.1 rated.

3) Net design must allow for quick one-handed removal in the event of an accident.

a) The net must be mounted securely at the top and bottom with provision for a quick one-handed disconnect at one of the top ends of the net.

b) The quick release must be easily visible from outside the car.

c) Drop down nets are required to minimize possible complications during emergency exit or extraction from the vehicle.

4) Interior (right side nets), designed to capture the head and should in angled or side impacts, are required.

a) Attach the triangular-shaped net to the roll cage just behind the seat.

- i) Upper part captures the head just below the line of sight
- ii) Lower part capturing at least 6 inches below the top shoulder.
- iii) Net should wrap around the seat at least a few inches to provide additional support to the upper part of the seat.
- iv) Net should be attached to the front part of the cage, the chassis, or a combination of both with a quick release lever toward the front attachment point for emergency exit.



- b) The right side net can be attached either to the cage, the chassis, or a combination of both.
  - i) When a car's roll cage has no dash cross bar, a cable may be run from the firewall (connected to the firewall using heavy backing plates) to just past the dash (after removing the radio or center vent as required).
  - ii) The interior net's front connection may then be made to that cable.

#### 17. Oil Lines

- a. All oil lines on the pressure side of the oil pump must be thread-on connections equal to or better than that of the factory.
- b. Slip-on oil lines to coolers, gauges, and so forth are not allowed.

#### 18. Battery Terminal

- a. The positive battery terminal must be fully insulated.
- b. No part of the positive battery terminal or uninsulated portion of the positive battery cable may be visible.
- c. A sealed marine-style battery box satisfies this requirement.

#### 19. Engine Coolant

- a. Use of an antifreeze/coolant substitute (for example, "Water Wetter") is highly encouraged for all competitors.
- b. Antifreeze may only be used when deemed necessary for climatic reasons.
- c. As some local tracks and racing venues prohibit the use of ethylene glycol, race cars using ethylene glycol may be prohibited from participation.

#### 20. Catch Tank

- a. A catch tank for radiator overflow and oil breather (if vented into the atmosphere) are mandatory.
- b. Transmission breather catch tanks are strongly recommended.
- c. Differential breather catch tanks are permitted.

#### 21. Fuel and oil Hoses

If any fuel or oil hose or lines pass into the driver's compartment, they must be stainless, Kevlar braided, or rigid metallic.

#### 22. Heater Cores

May be bypassed in all classes using a straight bypass or bypass valve.

#### 23. Hubcaps, trim rings, and so forth must be removed.

#### 24. Lug Nuts

- a. Must be original manufacturer specification with engagement at least equal to the diameter of the wheel lug studs.
- b. The use of wheel studs to replace lug bolts is allowed and highly recommended.
- c. Wheel studs and nuts and/or lug bolts must be replaced every three years.

#### 25. Electrical Cut-off Switch

- a. A standard, approved decal must be mounted externally in an approved location, preferably on the driver's side on all race cars.
- b. The switch must disconnect the battery from all circuits, except on an electronically operated fire system.
- c. The switch must shut off the engine and alternator while it is running.
- d. The method of operation may be by pull wire, requiring no external body modification. (See Appendix C).

#### 26. Hood Pins

- a. Hood pins are allowed in all classes, but this does not permit the removal of stock hinges where not permitted under other rules.
- b. The stock latching mechanism may be removed when at least two hood pins are used to hold the hood closed.

#### 27. In Car Camera recording a front facing view is required.

- a. All cars will be required to have in car cameras mounted and operational during qualifying and race sessions recording at a resolution of 720P (1280x720) or higher. Racers are encouraged to have a backup means of video recording (extra memory card or other video recording device) to use in the event stewards have possession of the primary memory card. A steward having your memory card is not an excuse for no video.
- b. Any racer who can not produce a useable video upon request of the stewards (whether involved in an incident or not) will be assessed a penalty.
- c. Event Stewards will request access of camera data during an incident investigation.
- d. In a review of an incident from any participant, Penalties may include DQ, reassign position (Back of the pack) at the discretion of the Comp Steward.

#### 28. Sound Level

- a. All competitors' cars must not exceed a maximum sound emission level of 103 dB as measured from a distance of 50 feet from the edge of the track.

**Note:** Many tracks now have sound limits as low as 89 db.

- b. More restrictive standards may apply by a track or event.
- c. Competitors bear sole responsibility to determine that their vehicles comply with Sound Control Regulations at each event.
- d. Mufflers may be required.

## 29. Fuel System

- a. Fuel cells may be used in classes where allowed. Racers are required to execute a BMW Club Racing Fuel Cell Waiver when a fuel cell is utilized.
  - I. If a fuel cell is used, the stock tank may be retained or replaced.
  - II. If retained, only one of either the fuel cell or stock tank may provide fuel for combustion.
  - III. In such cases, the remaining storage source (cell or tank) must be empty of any and all substances, except that the fuel cell may retain the bladder and foam.
  - IV. All safety fuel cells must be constructed and certified in accordance with FIA FT-3 or higher (FT-3, FT-5 and so forth) specifications.
  - V. Fuel cell bladders require recertification by the manufacturer after five years.
    - Only one recertification good for two years is permitted
    - Bladders, thus, have a seven-year total life after which they must be replaced.
- b. Fuel Cell Location
  - I. Fuel cells be located within 12 inches of the original fuel tank location, except in models where the original fuel tank is located beneath the rear seats, in which case the cell must be mounted in the trunk unless utilizing a Merin Fuel Cell as outlined in 29. C. below.
  - II. Additional reinforcement may be added to support the fuel cell, but such reinforcement must not be attached to the roll cage in Sport and Prepared classes.
  - III. The floor pan may be modified for installation, but not for aerodynamic benefit.
  - IV. A sealed metal bulkhead between the driver/passenger compartment and the compartment containing the fuel cell is required.
  - V. BMW factory delivered race cars (M235iR, M2 CS Racing, etc.) are exempt from Fuel Cell Location rules if the fuel cell and its location remain as delivered from the factory.
- c. Cars with factory fuel tank located below the rear seat may utilize the Merin fuel cell (models SFT/1860, SFT/2451, SFT/2412, SFT/2700, SFT/2195) which is designed to be utilized in the original factory location below the rear seat. No other fuel cells are allowed to be used in this location. The Merin cells are allowed provided:
  - I. They are mounted to the specific BMW model the Manufacturer designed them for and
  - II. Fuel cells are installed to FIA and Manufacturer's guidelines and

- III. Racer executes and submits to Club Racing a Fuel Cell Waiver accepting full responsibility for the safe installation and maintenance of the Fuel Cell.
  - IV. Racers are also responsible for adhering to the FIA guidelines on Bladder recertification every 5 years. Proof of bladder recert/purchase/installation is required.
    - Note: Due to the location of these fuel cells, they are not readily accessible for inspection outside of a shop hence the Racer is responsible for the required maintenance and inspection of the cell and bladder as spelled out in the Fuel Cell Waiver. Assistance with the installation and required maintenance of these fuel cell from a Pro Level race shop is highly recommended.
  - V. The Merin Fuel Cells apply to BMW Models: E36, E46, E87, E90, E92.
- d. For cars in which the factory stock tank is non-metallic, all factory-installed heat shields must remain intact.

### 30. Rain lights

- a. A red FIA-certified high-intensity rear LED rain light is mandatory in all classes. FIA homologated BMW factory built race cars may use the built in FIA rain light(s) provided they adhere to the modes of operation specified in c. below.
- b. At least one functional, forward facing low beam equivalent headlight, (white or yellow) is required in all classes.
- c. The FIA-approved rain light must be steady "ON," when the brake pedal is depressed, and flashing when the brake pedal is not depressed.
  - I. Placement
    - The FIA-approved rain light must be secured to the exterior of the car on a vertical or near vertical surface in the center of the car (recommended mounting location is the rear license plate area unless FIA homologated BMW Factory Built).
- d. The forward-facing light may be a factory headlight, or an equivalent light mounted on the front of the car no lower than the front bumper and located no further back than the front wheels.
- e. The view of the rain light shall not be obstructed by glass, lenses, or other parts.
- f. The FIA-approved rain light and forward-facing light is required as part of the car's annual safety inspection.
- g. A list of FIA-approved rain light manufacturers can be found at [https://www.fia.com/sites/default/files/lt\\_19-feu\\_pluie.pdf](https://www.fia.com/sites/default/files/lt_19-feu_pluie.pdf)

### 31. Driver Egress Requirement

- a. The driver is required to be able to safely exit the car from a racing condition (all safety equipment in place, harnesses buckled and nets in place) within a 15 second time limit.

## C. Passengers

Passengers are not permitted on the track during any session run under a race sanction.



## IV. RACING RULES

### A. Characteristics of a Race

#### 1. Organization of BMW CCA Club Racing Events

a. Where and when possible, Club Racing officials will make announcements and provide course condition updates over radios on FRS channel 7, sub channel 1.

#### b. Race Starter

To be considered as having started a race, a driver must cross the starting line under green track conditions, with a car under its own power, at some time during the race, and before the checkered flag is displayed

#### c. Race Finisher

i. To be considered a finisher, a race car must complete at least half the distance covered by the overall winner of the race.

ii. If the race is an uneven number of laps, that distance will be determined by dividing the overall winner's laps by two and rounding down to the nearest integer.

iii. In cases of races of 55 minutes or longer in duration, the Competition Steward may exercise his discretion in determining an appropriate number of laps a car must complete to be considered as a finisher.

1) The Steward should consider the race length and disparity in class speeds between the overall winner and the race car(s) in question

2) The number of laps should reflect what the race car would be capable of running at reasonable speed over the length of the race.

3) The official results must specifically state that the Competition Steward has exercised this option and specify the applicable cars.

#### d. Each registered driver qualifies for a starting position during the qualifying session.

i. The car and driver combination qualifies for a starting position within a declared class.

ii. Each car is officially qualified only if the qualifying time is achieved by the driver nominated to drive that car.

#### e. Driver responsibility during qualifying sessions:

i. Drivers not running at full qualifying pace should be prepared to give way to overtaking drivers.

ii. Any driver who either intentionally or unintentionally interferes with any other drivers' qualifying laps may be penalized.

#### f. Impound

i. To promote careful adherence by all competitors to the car classification and preparation rules, Club Racing Stewards reserve the right to conduct impound and inspection of any or all race cars in any or all classes at any time.

1) Cars found to be at variance with the class rules will be denied their finishing positions or other penalty as deemed appropriate.

2) The variances will be recorded in the individual logbooks.

- ii. Stewards may direct all competing cars or selected classes be impounded, such as for weighing or compliance checks.
  - iii. Finishing position. Those cars must remain in the hot pits if not on the track unless released by an official.
  - iv. Once the session has ended, all or selected cars must then go directly to impound, as directed by an official.
  - v. Cars involved in incidents that result in injuries, or are due to mechanical failures will be impounded, inspected, and cleared to return to competition by assigned Tech Stewards. The Tech Steward will make a note in the car's logbook to confirm what was found, and that the car is cleared to return to competition.
- g. Any race car determined to be in violation of any rule or supplemental regulation will forfeit all timed qualifying laps accredited to that race car prior to such determination.

## 2. Starting Grid Order

- a. Grid ordering may vary over the course of an event.
  - i. Qualifying Session
    - 1) The driver that has the fastest single lap time during a qualifying session assumes the pole position.
    - 2) The subsequent grid positions are assigned in ascending time order using each driver's fastest single lap time.
    - 3) For races where a dedicated qualifying session does not exist, the Driver that has the single fastest lap during the prior race, assumes the pole position.
    - 4) The Competition Steward may change the gridding method only if clearly communicated before the affected qualifying event and subsequent race on the schedule
- b. Complete or partial inverting of grids may occur only when the race format provides for single car starts, such as simple starting position inversions or Australian Pursuit (handicap) races.
- c. The grid closes no later than 5 minutes before the scheduled start of a race
- d. Cars arriving on the grid after the grid closes forfeit their grid positions and will take positions at the back of the field in the order in which they arrive at the grid.
  - i. The Competition Steward keeps the official time.
- e. Unqualified car and driver combinations must take a grid position at the back of the field in the order in which they arrive at the grid.

## 3. Rolling Start

- a. Starts will normally be two abreast unless the Competition Steward directs a single file start based upon track conditions.
- b. Before cars leave the grid, the pole sitter will determine the side of the track, left or right, he or she wishes to start from.
  - i. When the car leaves the grid, the pole sitter assumes or is directed by a grid worker to his or her choice of side.
  - ii. The remaining cars move alternately to the opposite side of the car ahead of them, forming new rows as appropriate.
- c. When a pace car is used, the Starter, Grid Marshal, or Competition Steward will signal the pace car to begin moving before releasing the grid.
- d. The pace car sets the pace of the field.

- i. If a pace car is not used, the pole sitter will set the pace from his or her position on the front row.
  - ii. There will be at least one pace lap.
  - iii. Pace laps will be considerably slower than racing speed.
  - iv. The pole position car, as well as the balance of the field, must maintain the speed of the pace car, including when the pace car leaves the track in anticipation of a green flag.
- e. During the pace lap, the field must align into its proper starting columns and rows, and must be in perfect alignment in the last two turns before the start/finish line.
  - i. A car that fails to maintain its relative position during the pace lap forfeits its grid position. There will be no empty grid positions.
  - ii. A car that fails to maintain its relative grid position during the pace lap may rejoin at the rear of the field.
- f. During the pace lap, drivers should take care when weaving to warm up tires (“scrubbing tires”).

#### g. Split Starts

- a. Split starts (additional waves of separate large classes) may be used at the request of the Race Chair with the approval of the Competition Steward in order to facilitate improved in-class racing at the beginning of a race.
- b. Split starts should be limited to one or more large classes (> 4 cars). Smaller classes (even of similar speed cars) shall not be mixed into the subsequent waves.
- c. Under no circumstances are the split restarts used following a double yellow condition. In the event of a double yellow, the entire field should restart in a uniform single file formation. Any attempts to create a gap prior to the green flag will result in a penalty for the car creating the gap regardless of class.
- d. Split start gridding:
  - i. A single class split start will grid by qualifying time
  - ii. A split start with 2 classes will grid by qualifying time (mix of both classes) or
  - iii. Utilize a 3rd wave (separate green flag) with the 2nd split class separated from the 1st split class.

#### 4. Start of a Race

##### a. Green Flag Start

The starter, upon determining that the approaching field is at a constant and appropriate slow speed, with cars at close intervals and well-aligned, and with the field close enough to the starter that all drivers can see the flag, will suddenly and continuously wave the green flag until all cars have passed the start line.

##### b. No Start

- i. Should the starter determine that the field is not in good order, he or she shall abort the start by making no flag movements whatsoever, and at the same time vigorously shaking his or her head from side to side to signal all drivers that there has not been a start.
- ii. Drivers must continue another pace lap in their original starting positions with all flag stations displaying double yellow flags during all such pace laps.
- iii. Any additional pace laps count toward the race distance or time.

c. False Start

- i. If a driver accelerates before the green flag or moves out of position before the beginning of a race, or moves out of position before a restart, that driver has committed a false start.

d. Restarts

- i. Following the use of the pace car during a full course yellow condition, the race leader and the balance of the field must maintain the speed of the pace car, including once the pace car has left the track in anticipation of the green flag.
- ii. All cars must remain in single file order with no large gaps.

iii. Races with Split starts: under no circumstances are split restarts used following a double yellow condition. In the event of a double yellow, the entire field should restart in a uniform single file formation. Any attempts to create a gap prior to the green flag will result in a penalty for the car creating the gap regardless of class.

- 1) If the starter is satisfied that the field is aligned and in order, he or she will display a green flag and racing will resume throughout the field.
- 2) Once the green flag is displayed, racing has resumed and passing is allowed.

e. Race Length

- i. The race length may vary at each event.
- ii. It is the competitor's responsibility to ascertain the race length by information from the officials.

iii. Race Stoppage

- 1) A race may be shortened or stopped at the discretion of the Competition Steward.
- 2) Stoppage with less than 50 percent of time or distance, as applicable, completed by the overall leader, and the race is not restarted:
  - a) Considered an incomplete race
  - b) Not counted
  - c) No points or prizes awarded
- 3) Stoppage with at least 50 percent of time or distance, as applicable, completed by the overall leader, and the race is not restarted:
  - a) Considered a complete race
  - b) If a full course yellow occurred before the stoppage, a stopped race is scored at the finish line in order of last scored lap before the "black flag all" or "red flag" condition.

f. On Course Driver Conduct

- i. It is the driver's responsibility to avoid contact between cars on the racetrack.
- ii. Each competitor has a right to racing room, which is generally defined as sufficient space on the marked racing surface that under racing conditions, a driver can maintain control of his car in close quarters.
- iii. Drivers must respect the right of other competitors to racing room. Abrupt changes in direction that impede or affect the path of another car attempting to overtake or pass may be interpreted as an effort to deprive a fellow competitor of the right to racing room.

BMW CCA Club Racing Rules 2026 – 1/30/2026

- iv. The overtaking driver is responsible for safely passing another car.
  - 1) The overtaken driver is responsible for avoiding impediment or blockage of the overtaking car.
  - 2) A driver who does not use his or her rear-view mirror or who appears to be blocking another car attempting to pass may be black flagged and possibly penalized.
- g. Racing Under Non-Green Flag Conditions
- i. Yellow Flag
    - 1) No passing is allowed from a point tangential to the first station displaying a yellow flag until safely past the incident **and** until such point as the racer can visually confirm that the next staffed corner station is in a green-flag (no flag) condition.
    - 2) It is the driver's responsibility to be aware that more than one station might display a yellow flag, and, therefore, cannot pass until the conditions described above can be established.
    - 3) If a driver inadvertently passes under a yellow flag condition, he or she may "wave by" the car(s) passed.
      - a) The Competition Steward's judgment prevails regarding passing under the yellow penalties.
      - b) The Competition Steward retains full authority in determining whether a penalty is appropriate regardless of any effort on the part of the offending driver to correct the error.
      - c) The emphasis is on driver awareness and proper procedure rather than correction of error.
  - ii. Red Flag
    - 1) The session clock stops when the Chief Steward declares a red flag condition.
    - 2) On Course
      - a) When a red flag condition has been declared, and all stations display the red flag, drivers must stop on course as safely and quickly as possible.
      - b) When directed by the Chief Steward, stopped cars will be directed into the pits by the display of a black flag at all stations.
      - c) All race cars that were on the track when the red flag was declared will be placed back onto the track first, followed by race cars from the pit lane in the order in which they arrived in hot pit lane.
    - 3) Pit Lane
      - a) If a race car entered the pits before the red flag declaration, no pit activity may begin and all pit stop activity in progress must immediately stop, including, but not limited to the following:
        - i) Any service
        - ii) Driver change
        - iii) Repairs
      - b) Activity may begin once the cars are released from pit lane under a full course yellow condition.
      - c) Cars in the pits when the red flag condition was declared may not exit their assigned pit until all other race cars that were on track have reentered the track

for the restart and will follow the on track cars in the order in which they arrived in the pit lane.

4) Mandatory 5-minute Pit Stop

- a) Cars may not begin **or** continue a mandatory 5-minute pit stop under a red flag track condition.
- b) When the session clock stops, the 5-minute pit stop clock also stops.

B. Pit Stop and Pit Lane

1. The hot pits include the pit area adjacent to each side of the pit wall, usually marked with pit boxes.
2. No smoking is allowed in the hot or cold pits
3. No children under 16 years of age are allowed in the hot pits.
4. The maximum pit lane speed limit is 35 mph (in and out) for all tracks and events, unless the local track has a lower speed limit, in which case the lower speed limit will be in effect.
5. The green flag and checkered flag cannot be taken in the pits unless the vehicle is experiencing a mechanical failure.
6. Crews in Pit Lane
  - a. All crew member in the hot pits must wear the following:
    - i. Long pants
    - ii. Natural fiber shirt
    - iii. Socks
    - iv. Shoes
    - 1) Sandals are not allowed.
    - 2) Open-toed shoes are not allowed.
  - b. Only one crew member is permitted in the hot pit to signal the driver.
  - c. No more than three crew members may be in the pit lane for fueling.
    - i. Two fuelers
    - ii. One fireman
  - d. No tools, equipment, tires, or crew (except to signal driver) are permitted in the pit lane or on top of the wall until the car has come to a complete stop in its pit box.
7. Race cars are prohibited from using reverse in the pit lane. Crews may push a car back into the pit box.
8. Fueling
  - a. When refueling is allowed in the hot pit, the car must have wheels stopped for a minimum of five minutes.
    - i. Engine must be turned off.
    - ii. Driver must exit the car.
    - iii. No other work may be performed on the car.
  - b. Fueling begins when the fuel system is open, or a dry break is breached and ends when the fuel system is resealed.

c. Fuel Team

i. The fueling team may have up to two fuelers plus one mandatory fireman.

ii. Fuelers and firemen must wear the following:

- 1) Full Nomex suit
- 2) Nomex gloves
- 3) Balaclava
- 4) Full face Nomex-lined helmet

iii. Fireman

- 1) The fireman must have no other duties during fueling.
- 2) All teams must provide their own fire extinguisher.
  - a) Minimum nominal capacity – 10 pounds
  - b) Minimum UL rating – 60B:C
- 3) The fireman must stand 6 feet behind and back from the fueler(s) during fueling.
- 4) The fireman must pull the pin and aim the nozzle at the refueling point during fueling, which ensure the fire bottle is immediately dispensable.
  - a. No fuel container may be placed on the wall or on the ground in the hot pit.
  - b. Fuel spills larger than 9 inches in diameter will be penalized.
  - c. A fuel catch pan is allowed to be placed on the ground below the car's fuel filler neck. This is encouraged when required by the specific track for protection of the pavement.
- 5) Severe disregard for safety requirements and procedures may result in disqualification.

C. Driver Change

1. Driver changes are allowed during pit stops in any session.
2. Only registered, credentialed racers or race officials are allowed to drive on course during any type of race session including Practice, Qual, Race or other type of on track activity.
3. Alternate drivers must be registered for the event and with Timing and Scoring for the entrant's results to be counted and to be eligible for drawings or points.
4. Multiple driver cars must register as such **before** the first on-track session.
  - a. Each driver is responsible for providing the event Timing and Scoring Steward with the driver in the car before the start of each session.
5. Eligibility for Event Sponsored Drawings
  - a. Driven at least 25 percent of laps in a race - eligible
  - b. Shortened race without completing laps – not eligible
6. Appendix F North American Points System specifies points for multi-driver vehicles.

D. Rain Race

1. The Competition Steward for the race shall determine if the race is to be categorized as a "rain race."

2. To be allowed to run in a rain race, all cars must have at least two functioning taillights, an FIA-approved rain light, and a forward-facing headlight.
3. Cars not displaying a rain light during a rain race, may be Black Flagged at Competition Steward's discretion based on track visibility.
4. Rain light Requirements – See Safety Equipment Section Item 30

#### E. Enduro Rules

1. An endurance race or “enduro” is a race with a scheduled duration of greater than 45 minutes.
2. The minimum prepared class weight will be measured with the lightest of all drivers who compete in the car (prepared = vehicle's race status; Prepared = car class).
3. The driver who qualifies the race car must start the endurance race.
  - a. If another driver starts the race, the car must start from the back of the grid.
  - b. If qualifying positions are determined by the finishing position of a sprint race, the driver who drove that race must start the endurance race or the car must start from the back of the grid if another driver begins the enduro.
  - c. If circumstances prevent a qualifying or sprint race session, such as a cancellation, the Competition Steward may override the starting driver or grid due to the event's special circumstances.
4. The green flag and checkered flag cannot be taken in the pits unless the vehicle is experiencing a mechanical failure.
5. Pit Stops
  - a. Required Pit Stops for all Enduro races.

<b>Length (minutes)</b>	<b># of Pit Stops</b>
Up to 90 minutes	1
Over 90 minutes	+1 for every 45 minutes Examples: 120 minutes = 2 pit stops 150 minutes = 3 pit stops

- b. Timing of Pit Stops
  - i. 5 minutes
  - ii. Mandatory pit stops begin as wheels stop.
  - iii. Each team is responsible for timing their pit stop.
  - iv. Organizers might have additional personnel timing pit stops but are not obligated to provide timing for competitors.
  - v. The organizers or race chair may, at their discretion, eliminate the mandatory pit stop, including the mandatory 5-minute pit stop, or may amend the pit stop to a specific format per the race chair or organizers.
- 1) If the pit stop is eliminated or the format is changed, the event organizers should post the information on the Club Racing Calendar when they post the event.

- 2) If the eliminated or amended pit stop format was not posted on the Club Racing Calendar, it **must** be posted when registration opens for the event.
- 3) If pit stops are eliminated or amended, the Competition Steward may open pit lane during yellow flag conditions once the field is under control of the pace car.
- 4) The decision to open pit lane during yellow flag conditions, and the method to inform drivers and crews when the pit lane is open (radio, flagging, and so forth) will be announced at the first drivers' meeting of the event.
- 5) All other pit lane and fueling rules remain in effect.
- 6) Additional stops during the race are allowed but will not be counted towards the mandatory pit stop requirement if they are shorter than the 5 minute, wheels-stopped minimum.

vi. Start of Mandatory Pit Stop

- 1) A mandatory pit stop may not start before the car's completion of its first full lap after the start of the race, except as noted below in the Mechanical Black Flag item.
- 2) A mandatory pit stop must start before the point in the race when less than 10 minutes remain in the scheduled race length.
  - a) The stop officially begins when the car comes to a complete stop in its assigned pit box.
  - b) With 10 minutes remaining and continuing to the checker flag, the pits will be closed except for safety-related stops.

6. Penalties

a. Failure to Complete Mandatory Pit Stop(s)

- i. Failure to make a mandatory pit stop will result in a time penalty equal to the sum of the following equation:

the time of the minimum pit stop (5 minutes)  
 + pit lane transit time (including entry and exit time)  
 + an additional two minutes

b. Multiple Required Pit Stops

- i. If multiple required pit stops have not been completed, the penalty will be applied for each missed pit stop.
- ii. The penalty will be applied separately for each mandatory stop that is missed.

- 3) Pitting outside the allowable pit stop window will result in a one-lap penalty.

c. All time penalties applied during a stop-and-go penalty will be under green flag racing conditions and may not be considered part of any mandatory pit stop.

d. Premature Race Ending

- i. If a race is prematurely ended by a "black flag all" or red flag, no penalty or time assessment will be given to those cars that were in the pits when the track condition was declared.
- ii. Those race cars that had not yet pitted prior to the track condition being declared will not be given a penalty or time assessment.

- iii. As the decision when to pit is that of the driver, any advantage or disadvantage of that decision is borne strictly by the driver.
- iv. Timing and Scoring will consider the order of entry of on-track race cars into pit lane as that of the running order for the last scored lap, subject to adjustment for any improper passes executed under the red flag condition.

7. Driver Change

- a. Any enduro scheduled for more than 120 minutes requires a driver change.

## V. DRIVER CONDUCT: INCIDENTS, PENALTIES, APPEALS (AND PROTESTS)

### A. Driver Conduct: Incidents, Penalties and Appeals

BMW CCA Club Racing operates under 13/13 Vintage Racing rules; rules and processes overseeing driver conduct as described in this section are central to the objectives and aspirations defined in the Spirit of Club Racing.

Club Racing puts a high value on decision consistency – the National Competition and National Technical Stewards will conduct event after action reviews with the Competition and Lead Technical Steward after each race to ensure lessons learned are shared with the full Club Racing stewarding team.

BMW CCA Club Racing is the sole and final authority in administering these rules – penalty decisions are made exclusively to advance the interests of BMW CCA Club Racing. BMW CCA Club Racing reserves the right to amend or alter these rules at any time at its sole discretion.

#### 1. Penalties

- a. Minimum penalties are defined below - Club Racing Competition Stewards may deviate from these guidelines by documenting extenuating circumstances.

<b>Unacceptable driver conduct</b>	<b>Minimum Penalty Consequence for at fault incidences (E=event)</b>
<b>On track behavior</b>	
Incidents resulting in contact (single car)	2E Probation, DQ / points loss for the infraction race for non-incidental contact*
Incidents resulting in contact (multi-car, primary responsibility)	4E Probation, DQ / points loss for the infraction race for non-incidental contact*
Incidents resulting in contact (multi-car, secondary responsibility)	2E Probation, DQ / points loss for the infraction race for non-incidental contact*
Loss of control of car (with no resulting damage) that is determined to be a contributor of other car(s) contact/damage (single or multi-car)	4E Probation, DQ / points loss for the infraction race for non-incidental contact*
Failure to report contact	2E Probation, DQ / points loss for the infraction race
Mechanical failure due to negligent maintenance and/or preparation resulting in contact	2E Probation, DQ / points loss for the infraction race
Passing under black or yellow flag	A 30 second time penalty for the infraction race
Unsafe operation near Emergency Vehicle crews	2E Probation, DQ / points loss for the infraction race
Reckless and dangerous driving or behavior (failure to obey red flag requirements is included in this category)	4E Probation, DQ / points loss for the infraction race
Jumping the start, including when part of the second group in a split race start	A 30 second time penalty will be assessed
Failure to properly notify the Timing and Scoring Steward of a registered co-driver in an enduro before a session	A 30 second time penalty will be assessed

Unlicensed, including previously but now noncurrent, and unregistered drivers in any on-track session	Disqualification, expulsion from the event of the car, the registered entrant, and all associated crew plus suspension of the entrant for a minimum of 6 months
Exceeding Track Limits***: Race Session First infraction	First infraction is free
Exceeding Track Limits***: Race Session Second infraction	A furred black flag warning.
Exceeding Track Limits***: Race Session Third and subsequent infraction(s)	A black flag stop and go penalty – excessive violations will be penalized at the discretion of the Competition Steward. Additionally, if a racer receives an ETL penalty during a race where the race results determine the grid of a subsequent race, the racer will start at the back of the field for the subsequent race.
Exceeding Track Limits***: Qualifying Session – First Infraction	A furred black flag with a penalty of deletion of the fastest qual lap during the session
Exceeding Track Limits***: Qualifying Session – Second infraction	A furred back flag with a penalty of 2 grid positions
Exceeding Track Limits***: Qualifying Session – Third Infraction	All qualifying times will be deleted – racer must start at the back of the field.
<b>Hot Pits (non-race session violations to be applied to subsequent race session)</b>	
Fire safety rules compliance violation (see rules Section IV part B and Part D - Enduros)	Immediate correction of the infraction and a one lap penalty assessment
Work of any kind except the measurement of tire conditions while driver is in the car during a pit stop	A one-lap penalty will be assessed
Exceeding pit lane speed limit	A one-lap penalty will be assessed
Too many crew members over the wall during a pit stop	A one-lap penalty will be assessed
<b>Enduro Race requirements (also see Hot Pits section)</b>	
Failure to execute required pit stops per Enduro race rules	Timing and scoring consequences are specified in the enduro rules section
<b>Unsportsmanlike conduct (on or off the track), including:</b>	
Failure to provide requested information (including session video, a copy of which will be retained by Club Racing and may be used for training purposes)	1E Probation
Conversations or confrontations that do not represent the Spirit of BMW Club Racing	2E Probation, DQ / points loss for the infraction race
Reckless or unsportsmanlike conduct by driver's crew or spectators	2E Probation, DQ / points loss for the infraction race
Late or missed drivers' meeting	Loss of qualifying position for the 1 <sup>st</sup> race of the event
Ignoring a black flag	DQ / points loss for the infraction race
<b>Technical Compliance Penalties</b>	

Incidental Weight Violation (less than or equal to 1% of class limit or declared weight for PWR)	DQ for the specific race; Correction required to continue.
Egregious Weight Violation (Greater than 1% of class limit or declared weight for PWR)	DQ for the Race and all prior races of the event; Correction required to continue. (NRT will confirm prior to event DQ finalization)
Incidental Dyno/HP Violation** (less than 3% or class limit; for PWR class must calculate HP/Wt ratio for adjudication)	DQ for the specific race; Correction required to continue.
Egregious Dyno/HP Violation** (Greater than 3% of class limit; PWR class must calculate HP/Wt ratio for adjudication)	DQ for the Race and all prior races of the event; Correction required to continue. (NRT will confirm prior to event DQ finalization)
Technical rule violation (other than weight or HP).	DQ for the Race and all applicable prior races and events as appropriate. Correction required to continue.
Repeated mechanical or electrical failures	A racer causing 2 separate yellow flag events in a race weekend resulting from these failures will not be allowed to continue for the event
Return to the track without Tech inspection/approval after an incident or mechanical failure for which a Technical Steward specified inspection required in the car's logbook.	DQ for the specific race; Correction required to continue.

\*Incidental Contact is defined as: non-intentional minor contact between two cars where nothing more than cosmetic damage occurs and neither car is knocked off line as a result of the contact. Certain Exceptions will apply. Such as: 1) As a result of the contact, the race position of the cars is materially affected (including other in-class cars in the vicinity) 2) Cosmetic damage occurs to 2 or more body panels on either car.

\*\*PWR Class - A failed dyno power test triggers a HP/Wt calculation based on actual weight at the time of the dyno run. If the calculated ratio is within the legal range for the class, no penalty will be assessed. If the calculated ratio is less than or equal to 3% of the class limit the violation is considered incidental. If the calculated ratio is greater than 3% of the class limit the violation is considered egregious.

\*\*\*Exceeding Track Limits (ETL) is defined by all 4 tires outside of the defined track surface (typically defined by white lines) in which a competitive advantage is achieved (time advantage or a position advantage/pass). ETL applies to the entire track but certain corners may be designated as ETL focus areas on a Track by Track basis. Competition Stewards will announce which corners are ETL focus areas at the Driver's Meeting. ETL infractions will be reported by corner workers. The cornerworker's ETL infraction reports are final and will not be disputed.

- b. **Penalty Consequences** are supported by the following adjudication guidelines (event penalties issued for behaviors other than for contact reinforce Club Racing's expectation that driver conduct must always reflect expectations expressed in the Spirit of Club Racing).
- I. **Time penalties** – multiple infractions will incur more significant penalties
  - II. **Starting grid adjustment** –late arrival at the grid forfeits qualifying position
  - III. **Contact incidents:**
    - **Incident responsibility** may be shared or may be assigned to a single driver.
    - **Probation** penalties will be assigned for at least the minimum specified number of events (up to 13) in which the racer competes (a driver already on probation may not have probation extended at an event).
    - **Any driver on probation for greater than 4 events during a season will not be eligible for National or Regional Championship awards. Any**

BMW CCA Club Racing Rules 2026 – 1/30/2026

**probational period that carries over to a new season will be included in the cumulative total for the new season.**

- **Suspension** may be recommended by a Competition Steward if an incident is the result of an egregious action, if the racer is currently on probation or if a racer exhibits extreme behavior of unsportsmanlike conduct. A recommendation of a suspension will be forwarded to the National Competition Steward for National Review and final determination. This review may focus solely on the incident, but may also consider current license status, prior history and penalties assessed and any special circumstances that may be relevant to the decision. for a defined number of months between 6 and 13.

**IV. Damage to the track or facility**

- At fault drivers are responsible for costs assessed by damage caused by their racecar to the facility - failure to comply with payment will result in suspension of license.
- In case of damage to the track or facility by a racecar driven by a driver not at fault in a multi-car contact incident, the driver(s) at fault for the incident will be responsible for damage costs assessed by the facility for the collected car - failure to comply with payment will result in suspension of license.

**V. Penalty Confidentiality**

- Penalties are not confidential.
- Protests and appeals are confidential until they are decided and are not confidential afterwards.
- BMW CCA Club Racing officials will post final results of protests, penalties, and appeals on the Club Racing website.

**2. Incident management**

- a. Any single- or multi-car incident requires all involved drivers to report to the event Technical Steward within 30 minutes of the checkered flag and complete an incident form, submit a video card, and present the car for assessment. The Technical steward will note:
  - I. Any injury (medical checks are required following incidents with a significant impact).
  - II. Car damage (to be photographed for repair reference and noted in the driver's logbook, including any requirement for inspection prior to returning to the track).
  - III. Facility damage
  - IV. Confirmation of mechanical failure (note - mechanical failure due to negligent preparation or maintenance that causes an incident is the driver's responsibility – penalties still may apply).
  - V. All car damage noted by a Technical Steward as requiring repair before return in any involved driver's logbook must have that inspection completed by a Club Racing Technical Steward and the logbook must be noted as "safe to race" before that car can return to the racetrack.
- b. The Competition Steward will decide on fault and assess penalties based on:
  - I. Incident reports from all drivers involved, and from observer reports
  - II. Tech Steward inspection and damage reports
  - III. Video evidence from all drivers involved, and from observers
  - IV. Corner worker reports
  - V. Minimum penalty requirements shown above in sections V. A. 1. a & b
- c. Incidents involving drivers on probation may result in additional penalties, to be determined by the Competition Steward, and may include:
  - I. A recommendation for Suspension (when this recommendation is made, the driver may not continue participation at the event at which the penalty was issued)

- II. A recommendation to extend the driver's existing probationary period (please note that a decision to extend a probationary period requires National review that will include review of the previous three years of the driver's conduct. Under this scenario, the recommendation by the comp steward to extend probation for a driver already on probation does not require discontinuation of participation at the event at which the new penalty is assessed).
- d. A driver found at fault for an incident and penalized will:
  - I. Be listed as disqualified (DQ) in any applicable race results for that race and be placed on probation or suspension.
  - II. b. Have no points awarded for the race in which a penalty was given (or for the entire weekend - including participation points at the discretion of the Competition Steward).
  - III. In the case when a probation decision is made before the next scheduled race, the driver will lose grid position for that next race and start from the back of their grid (when running split starts this means gridding is at the back of the group the driver is competing in).
  - IV. Be ineligible for contingency awards for the event at which the penalty was assessed.
  - V. Have their hard card retained by Club Racing
  - VI. For future events the driver must follow the instructions on the penalty letter (which will be their temporary license) for future participation, which include these requirements for each subsequent race event the driver participates in while on probation:
    - At the start of each race event, deliver the temporary license to the event Competition Steward.
    - Attend each rookie driver's meeting
    - Assuming a penalty free weekend, receive back the penalty letter from the Competition Steward which will have been signed to acknowledge the penalty free racing.
- e. A driver found not to be at fault will have their hard card license and video returned – any damage requiring repair that is noted by the Technical Steward in the driver's logbook must have the specified repairs completed before returning to the racetrack.

### 3. Incidents requiring post-event resolution

- a. All incidents will be resolved as soon as practical utilizing available information
- b. Whenever possible, penalty decisions will be communicated to the drivers involved before the next track session, followed by written notification:
  - I. The Competition Steward will review the incident report and their decision with the drivers involved – if time allows, video review may also be part of feedback to the driver(s).
  - II. A penalty letter detailing the probation consequences will be supplied to the driver(s) – this document will temporarily replace the hard card license retained by Club Racing.
  - III. If additional post-event review is required, Club Racing will notify the drivers involved of the outcome in writing within 5 business days of the last day of the event. This may be by email or USPS mail, using contact info listed in the CR MotorsportReg.com database.

### 4. National Review

- a. The National Review Team (NRT) may be enlisted to review information and make a final decision under the following circumstances:

- I. Following an event at which a driver receives a probationary penalty and wishes to appeal.
  - II. Following an event at which a driver already on probation receives an additional penalty and review of the recommendation for suspension or extension of probation by the event comp steward is required.
  - III. Following an event at which a driver receives a race disqualification for violation of technical compliance rules and the competition steward has recommended disqualification/points loss for all races completed by the driver at that event.
  - IV. When a driver who has completed a period of suspension wishes to reapply for a Club Racing license.
  - V. When a driver is repeatedly penalized for poor judgment, poor situational awareness, or failure to exhibit adequate car control and the circumstances warrant consideration of a fitness review.
- b. The National Review Team is comprised of the following members:
    - I. National Competition Steward
    - II. National Rules Director
    - III. National Technical Steward
    - IV. CR chairman (tie breaker)
    - V. A non-voting member at large chosen from the ranks of licensed Club Racing drivers (12-month term – this member will take part only in appeal reviews).
    - VI. Two alternates will be designated at the start of each race season (12-month term)
  - c. An NRT member involved in an incident, or who was an official at the event where the appealed incident occurred must recuse themselves from any decisions following that event.
  - d. When the NRT is convened to review an appeal, the event stewards will be contacted before the NRT meeting for input and context about the appealed incident.

#### **5. Driver Appeals – Probation Penalties**

- a. Appeals of official decisions at an event are not permitted.
- b. Appeal process:
  - I. Within 5 business days following an event at which a probation penalty decision is made, the appellant must email the National Competition Steward notifying Club Racing of the driver's request to appeal the penalty decision – the email must include the following information:
    - Incident details (name, event, penalty received)
    - Justification for the appeal (a statement of no more than 500 words describing the rationale for the appeal and referencing the relevant rule(s) the driver wishes to have reviewed).
    - iii. Additional evidence in support of the driver's supplied appeal statement
  - II. Within 5 additional business days, the National Competition Steward will respond to the appellant with Club Racing's decision on whether to convene the NRT. Appeal requests not fulfilling the requirements listed in b.I. above will be declined.
  - III. If the NRT is convened to consider the appeal.
    - The appellant and other drivers involved in the incident will be informed of the review.
    - The appellant and other drivers involved in the incident may be requested to provide clarifying information.
    - The appellant and other drivers involved in the incident will be informed of Club Racing's decision within 10 additional business days (for the avoidance of doubt, the full appeal process will be concluded not more than 20 business days following the date at which the appealed decision was made).
- c. **Appeal Decisions:**

- I. The Club Racing NRT team will make all decisions as to whether the appeal is well founded and to what extent, if any, the appealed penalty decisions shall be increased, decreased, modified, redirected, or overturned.
- II. New penalties may be issued in unusual circumstances as part of an NRT review
- III. Penalties issued by the NRT are final and cannot be appealed.
- IV. Committee actions and decisions are decided by majority vote.

## 6. Suspensions

- a. A suspension may be recommended by a Competition Steward if an incident is the result of an egregious action, if the racer is currently on probation, or if a racer exhibits extreme behavior of unsportsmanlike conduct.
- b. A recommendation of a suspension will be forwarded to the National Competition Steward who will convene the NRT for final determination. This review may focus solely on the incident, but may also consider current license status, prior history and penalties assessed, and any special circumstances that may be relevant to the decision.
- c. Suspended drivers will lose eligibility for all annual National and Challenge annual awards
- d. At the end of a suspension period, the driver should contact the National Club Racing License Administrator to request reinstatement:
  - I. Reinstatement is never automatic.
  - II. The request for reinstatement will be forwarded to the National Competition Steward and CR Chairman for NRT consideration.
- e. When requesting a return from the prescribed length of suspension, the racer will undergo a mandatory review of the application by the NRT.
  - I. The NRT may apply conditions or restrictions to the applicant's license, including:
    - Probation
    - Return to or extension of rookie status
    - Return to or extension of Provisional status
    - Additional experience or training which may include attending Club Racing's competition school
  - II. The NRT may decline to reissue a license if it is determined to be in the best interests of the program and its participants.
- f. Suspension decisions may not be appealed, but a request for reconsideration may be made, should new supporting information become available.
- g. Any driver on suspension for any duration is no longer eligible for National or Regional Championship Awards for that season. If the suspension period extends to a new season, the driver is not eligible for Awards for the new season.

## 7. Club Racing decisions

- a. All decisions of BMW CCA Club Racing stewards concerning safety, eligibility, competition, acceptance, or other issues covered by the rules are binding and cannot be protested or appealed at that event.
- b. A racer may submit a non-penalty related grievance by email within 5 business days following an event to the National Competition Steward.
- c. The National Competition Steward may, at their discretion alone, convene the NRT to review a grievance and determine appropriate action, if any.
- d. BMW CCA Club Racing is the sole and final authority in administering these rules – penalty decisions are made exclusively to advance the interests of BMW CCA Club Racing. BMW CCA Club Racing reserves the right to amend or alter these rules at any time at its sole discretion.

## 8. Penalty logistics and communications

- a. Drivers on probation or suspension are required to return their hard card license to the National office – this will usually be handled by the event competition steward but may require driver cooperation to return the hard card license by mail.
- b. Drivers on probation will be required to bring their penalty letter (which is their temporary racing license) to every event during which they are on probation. The competition steward at each of these subsequent events will sign off on each event for which the driver competes successfully (no incidents). When the number of steward signatures matches the duration of the probationary period, the driver must return their penalty letter to the National office for return of their hard card license.
- c. All penalties (including appeal outcomes) will be published on the Club Racing website within 20 days of the close of each event.
- d. Drivers on suspension upon reaching the end of a suspension period, should contact the National Club Racing License Administrator to request reinstatement via a NRT review.

## 9. Driver fitness

- a. The NRT may be convened by any NRT member to consider a driver who:
  - I. Is repeatedly penalized for poor judgment, poor situational awareness, or failure to exhibit adequate car control.
  - II. Has been the subject of multiple complaints from competitors regarding unsafe driving.
  - III. Consistently fails to exhibit behavior that is consistent with the Spirit of Club Racing (on or off track).
- b. In cases where the NRT is convened to consider driver fitness:
  - I. Club Racing's Medical Team may be consulted
  - II. Interviews with other drivers may be held
  - III. Deliberations and decisions will be confidential (any disclosed personal health information (PHI) will be deleted after the review is completed)
  - IV. Possible actions following a fitness review include suspension of the driver's Club Racing license for a period appropriate to the situation. If the suspension is not permanent, return to active competition will require adherence to section 6.e above.

## B. Protests

### 1. Purpose

- a. Ensure race cars are properly classified, which provides a fair basis for cars of similar performance potential to race each other
- b. Deliver sanctions against those racers who knowingly or unknowingly assign their cars to the incorrect class.

2. As racers self-classify cars, the protest process helps race officials ensure cars are correctly classified.

3. A protest is a proactive action to correct errors before a qualifying or race session to avoid making corrections or adjustments after the session(s).

### 4. Process

- a. An event participant or organizer may initiate a protest for the decision, act, or omission by the following for alleged violation of the rules:
  - I. Event organizer
  - II. Official

- III. Car
  - IV. Driver
  - V. Another person connected with the event
- b. Protests must meet the following requirements:
    - I. Submitted by an accepted entrant or organizer
    - II. Must be in writing on the official protest form (available on the BMW CCA Club Racing web site or from the Competition Steward) and contain the following information:
      - III. Violation description
      - IV. Signed by protester
      - V. Accompanied by a \$50 fee
  - c. Acceptable payment
    - I. Cash
    - II. Check made payable to BMW CCA Club Racing
  - d. Return of Fee
    - I. If the protest is upheld, the fee will be returned to the protester.
    - II. If the protest is not upheld, the fee will be deposited on behalf of BMW CCA Club Racing.
  - e. Protests against refusal of entry or license certification are not be allowed.
  - f. Once filed, a protest or official action must run its due course through the process.
  - g. The Protest Committee will inform the protested driver of the nature of the protest and indicate the specific components or actions under protest.
  - h. The Protest Committee has the right to impound any protested car and to determine the method of impound.
    - I. Failure by the protested driver to comply will result in the protest being upheld.
      - The driver will be disqualified from the event weekend
      - This disqualification is not appealable.
    - II. It is the protested driver's responsibility to present his car exactly when requested by the Protest Committee in such a manner that a proper inspection can be completed.
      - The car must remain unchanged until released by the Protest Committee.
      - Failure to comply will result in an event disqualification of the vehicle and other penalties may be imposed.
    - III. The Protest Committee is not required to provide any official paperwork to the protested driver until such time as the protest process is completed.
    - IV. When provided the paperwork, the protested driver will be provided a copy should they wish to file an appeal in the event of an upheld protest.
    - V. Protest Committee decisions are not appealable at the event.
  - i. For any inspection that is deemed too difficult or not feasible due to time constraints or facilities at the event, the event Technical Steward shall make arrangements to seal the vehicle or components so as to maintain a state of satisfactory impound until such time as an

inspection can be made at an alternate time and location. This time and location is to be determined by the Protest Committee and agreeable to the event Technical Steward. Arrangements will be made by the event Technical Steward to perform the inspection and submit the findings to the Protest Committee, after which they will render a ruling. This process must be completed within 30 days of the event or the protest will be upheld.

- j. The protest may request and specify that portions of the car be dismantled, inspected, or otherwise tested provided that the protester posts a cash bond with the Protest Committee sufficient to cover the total expense of disassembly, inspection, and reassembly.
  - I. If the car is found upon inspection to conform to the rules, the protester will forfeit the bond and it will then be used to cover costs involved.
    - If the actual costs are less than the posted bond, the difference will be returned to the protesting driver.
    - If the actual costs are more than the posted bond, the protesting driver must cover this difference.
  - II. If the car is found not to conform to the rules, the protester's bond will be returned and the driver of the protested car must bear all expenses including reimbursement of inspection costs.
    - The protested driver is subject to penalty.
  - III. If the protest requests that multiple assemblies of the car be dismantled and inspected, separate bonds are required for each major assembly.

For example, if the protest includes inspections of both the differential and the ECU, a separate bond for each will be established. If the differential is found to be nonconforming while the ECU is found legal, the bond for the differential will be returned to the protester while the bond for the ECU will be forfeited and used to cover costs involved with the ECU inspection.
  - IV. Posting of cash bonds is not required for official actions, and BMW CCA Club Racing will be responsible for applicable costs if the assembly is found to be compliant.
  - V. Certain inspections may be held over at the discretion of the Protest Committee, and then made after the event as a matter of convenience or technical need.
  - VI. The Protest Committee shall at a minimum hear the arguments of the protester and the protested racer.
    - They may also take other statements or investigate as deemed necessary by majority of the Committee members.
    - The Protest Committee will determine the validity of the Protest by majority vote.
  - VII. For upheld protests, the Protest Committee determines penalties appropriate to the seriousness of the offense.
  - VIII. The Protest Committee may deny any protest it deems to be spurious or a nuisance and retain the protest fee.
  - IX. If a car is found to be improperly classified or to have unauthorized modifications, any penalties (equal or differing) will be assessed against all event drivers of the car up to that time.
- k. Continuing After Upheld Protests
  - I. For any protest that is upheld via inspection, the protested competitor may opt to change noncompliant parts to continue to run in the car's original class for the remainder of the event provided the Protest Committee's penalty is not event disqualification.

- II. If the protest is upheld due to the competitor being disqualified for failure to comply with any part of the protest process, they shall not be allowed to continue to compete in their original class for the remainder of the event regardless of the Protest Committee's penalty decision.
- I. Protest Committee
  - I. The event's Competition Steward shall normally be the chairman of the Protest Committee.
    - The Competition Steward appoints two other committee members, one of who may be the event's Technical Steward.
    - The Competition Steward also appoints three alternate members and prominently post or announce all the names at the event before the first on-track session.
    - Alternates will act as committee members if any primary member is involved in the protest, has a conflict of interest, or is not available.
    - Due to protest volume or conflicts of interest, it is possible to have more than one Protest Committee at an event acting on separate matters.
    - Protest Committees remain empaneled until all protests are resolved or the deadline for filing event protests has passed.

## 5. Official Actions

- a. Any BMW CCA Club Racing official may file an official action, which functions in the same manner as a protest except that no fee is required.
- b. Official actions follow the same procedures for protests as explained in these sections.
- c. For the purpose of filing an official action, a racing official is an official with the responsibility and authority to conduct and supervise the event, including the following event officials:
  - I. Competition Steward
  - II. Technical Steward
  - III. Timing and Scoring Steward
  - IV. Any additional stewards officially assigned by BMW CCA Club Racing to assist the primary stewards

## VI. RULES PROCESS

- A. The BMW CCA Club Racing Rules Book is maintained online on the BMW CCA Club Racing web site.
- B. Rules Clarification
  1. The purpose of a Rules Clarification is to resolve questions about the written rules herein without requiring an official protest.
  2. The Club Racing Rules Committee makes all Rules Clarifications, with the National Technical Steward is responsible for communicating the clarification on the BMW CCA Club Racing web site.
  3. Request for a Rules Clarification
    - a. A request for clarification may be made by any BMW CCA member who possesses or has applied for a BMW CCA Club Racing license.
    - b. A BMW CCA member may request a rules clarification through the Club Racing web site.
    - c. The request must cite the rules page number, section, and paragraph of the item in question.
    - d. There is no charge for the request.
    - e. Informal questions from current or prospective racers are welcome at any time.
      - i. Clarification requests not submitted through the web site, and not published on the web site, have no standing and are not official clarifications.
      - ii. The Rules Clarification procedure facilitates formal inquiries or requested changes to the current rules.
  4. Response to a Rules Clarification
    - a. The Rules Committee will determine the response within 30 days of the request.
    - b. This response will be provided as follows:
      - i. Posted on the Club Racing web site
      - ii. Email reply
        - 1) Sent from the National Technical Steward
        - 2) Informs requester that the clarification is available on the Club Racing web site
    - c. The Rules Committee may decline to act on clarification requests if the Committee deems the request to be frivolous, or as requiring no clarification. The Rules Committee will inform the racer of this decision.
  5. Posted Rules Clarification
    - a. Considered part of the current year rules and, therefore, may be used in protest and enforcement action.
    - b. Effective immediately upon publication on the Club Racing web site
    - c. Integrated in the current rules as necessary and appropriate
    - d. Club Racing will inform all racers by email of all rule clarifications adopted and incorporated into the online rule book.
  6. BMW CCA Club Racing advise that racers relying on current published clarifications bring a printed copy of the clarifications to any events they attend.

## 7. Rule Changes

1. The rules present a stable platform for the limits on preparation and should not undergo philosophical changes on a continuing basis.
2. The Rules Committee Commitment
  - a. Maintaining the levels of preparation (stock, prepared and modified) as presented for a minimum period of two years.
  - b. Deferment of implementation dates of some changes to allow the racers to properly budget and plan.
  - c. Prevention of progressive upward movement in preparation levels, otherwise known as "class creep," which does not preclude the following:
    - i. Implementation of safety items
    - ii. Correction of errors or omissions
    - iii. Other such items that the Committee feels are necessary
3. Acceptance of Rule Changes
  1. The Rules Committee will accept changes throughout the on-going year and will review requests for acceptance on a periodic basis.
  2. Accepted rule changes become official immediately upon inclusion and incorporation into the current on-line rules.
  3. Changes to the online rules can come from Rules Clarifications and adopted rule changes.
  4. Club Racing will inform all racers by email of all rule changes adopted and incorporated into the online rule book.
  5. Club Racing Rules Committee
    1. The Club Racing Rules Committee is comprised of the following:
      - a. Club Racing Chairman, who will not normally cast a vote, except in circumstances where a tie must be broken, such as when another member is absent, has abstained, or has a conflict of interest.
      - b. National Competition Steward
      - c. National Technical Steward
      - d. One representative of the Racers Advisory Committee (RAC) appointed by the RAC. T
    2. The RAC must officially advise the Club Racing Chairman of its representational appointment by February 1st of each year. The appointment will continue until the end of the calendar year or until officially rescinded by the RAC.
    3. Rules Committee Members Availability
      - a. If the Club Racing Chairman is unavailable to serve on the committee, the National Competition Steward will preside over committee meetings and be responsible for the rules processes.
      - b. If the National Competition Steward or National Technical Steward not be available to serve on the committee, the Club Racing Chairman will appoint a temporary replacement from the pool of regional competition and technical stewards, as appropriate.
      - c. If the RAC member of the committee is not available to serve, the RAC will appoint another RAC member to replace him or her.
      - d. Continuation of Rules Process

- i. If any member of the Rules Committee is temporarily unavailable to attend a meeting or conference call or otherwise communicate with the rest of the committee, the committee may continue with the rules process.
- ii. Every effort must be made to ensure that final committee decisions are made with the participation of the full committee.

## VII. CAR CLASSIFICATIONS

### A. Non-BMW CCA Club Racing Classifications

1. BMWs (BMW manufactured chassis and engine combinations) prepared to and competing in other non-vintage regional or national sanctioning body programs may participate in BMW CCA Club Racing adhering to the applicable sanctioning body's class preparation rules and within the class for which they are prepared.
  - a. Competitors must have available the most current rules of the sanctioning body for the declared class.
  - b. Competitors must present the logbook with a current annual inspection by the sanctioning body for the declared class to Technical Inspection. This does not apply to the SPEC E46 class. Racers in the SPEC E46 class must adhere to the Club Racing annual tech process spelled out in section III.A.2.
    - i. If the sanctioning body does not issue logbooks or annual inspections, the competitor must provide evidence of recent participation in the declared class.
    - ii. All competition vehicles must complete technical inspection at each event for compliance with BMW CCA Club Racing safety requirements.
    - iii. If no logbook or evidence of recent participation in the declared class is available, the entrant must conform to the appropriate BMW CCA Club Racing rules.
  - c. Competitors must comply with all declared class vehicle preparation rules without exception.
  - d. Personal safety gear must meet or exceed BMW CCA Club Racing requirements.
    - i. Personal safety gear includes, but is not limited to head and neck restraint, suit, shoes, gloves, helmet, arm restraints, and so forth.
    - ii. Right side interior nets are required.
2. Non-BMW race cars may participate as an Exhibition Class.
  - a. Competitors must have an active competition license with an approved series (IMSA, SCCA, HSR, SVRA, NASA, PCA)
  - b. Competitors must obtain membership with BMW CCA.
  - c. Competitors must obtain a BMW CCA Club Racing license.
  - d. Competitors must meet all Club Racing personal and vehicle safety requirements.
3. Competitors with non-BMW race cars requesting participation in BMW CCA Club Racing events should belong to another race series, preferably one that shares a similar racing philosophy (safety and car preservation) and rules (13/13 vintage rules).
  - a. Competitors must present the logbook and a valid annual tech form.
  - b. The National Chairman will issue supplementary regulations regarding conduct of non-BMW vehicles at that event.
4. Sport, Prepared, Spec E36, Spec E30, Spec Mini, E30 M3 Touring Classes
  1. Cars in the classes of this section must be factory-equipped vehicles as delivered to the general public through factory-authorized United States BMW dealerships.
  2. Approved Weights
    - a. All race cars in the Sport, Prepared, Spec E36, and E30 M3 Touring classes must meet or exceed the minimum weight as specified in Appendix D.

- b. The race cars may be weighed at any time during the event.
  - c. Underweight Cars
    - i. After Practice or Qualifying Sessions
      - 1) The competitor must add ballast according to the ballast replacement rules to meet the minimum weight requirement.
      - 2) The competitor may be penalized.
        - a) The Tech Steward or Competition Steward will prohibit such a car from competing in blatant cases.
        - b) At minimum, the race car will start the next race from the back of the grid.
    - ii. After a Race
      - 1) An underweight race car after a race session will be disqualified from race results.
      - 2) A notation will be made on the current event page of the vehicle's logbook.
      - 3) The car must be weighed at the next event and must meet minimum weight requirements before being allowed to compete.
      - 4) The Competition Steward may also apply other penalties under the 13/13 Rule.
  - d. Current Weight Limits
  - e. Appendix D, Vehicle Classification and Specification list the published BMW NA or BMW AG weights
  - f. Vehicles of the same engineering designation (such as E36, E46), type (such as 325, 330, 318), configuration (such as two-door, four-door, all-wheel drive), and horsepower will be weight equalized to the lowest of the model year factory weights.
3. Sport, Prepared, Spec E36, E30 M3 Touring, and Spec E30 Class Race Cars
- a. Race cars in these classes are measured with the driver and their personal safety gear in the vehicle.
  - b. The total weight must meet or exceed the published allowed prepared weight.
4. Official Scales
- a. The scales at the event are the official scales for the event. To be clear, there is no grace weight associated with race weight at impound and racers are encouraged to manage the competition weight of their cars given inevitable variations in scales.
    - i. The scales will be open and available for drivers to weigh their cars prior to qualifying events.
    - ii. Open scale hours will be announced at the driver's meeting.
    - iii. Any car that does not meet the minimum weight as published in the Club Racing Rule Book will be deemed underweight.
  - b. The following scale configurations are acceptable:
    - i. Platform scales
    - ii. Individual scales that weigh 1 axle (2 wheels) at a time or
    - iii. Four individual scale pads that each weighs a single wheel.

**Note:** If all 4 wheels cannot be weighed simultaneously, the driver must be weighed separately from the car.

- c. If there is any doubt about the weight, the car must be weighed in both directions.
- d. A car that is underweight in impound will be reported to the Competition Steward
  - i. The car is subject to penalty.
  - ii. The weight will be noted in the event page of the vehicle logbook.
  - iii. The Technical Steward must weigh the car before the next on-track session, and the car must meet the proper minimum weight.

## 5. Sports Classes

- 1. The Sport classes provide an entry point that accurately reflects typical track car modifications. Beginning in January 2025, BMW models with factory installed Forced Induction are allowed in Sport Classes with engine tuning limitations.
  - a. The focus is on safety, budget, and reliability.
  - b. Updating or backdating is allowed provided the converted vehicle meets all specifications of the vehicle to which it is converted.
  - c. Sport classes are based on factory-published horsepower and weight.
    - i. Sport class race cars are weighed with the driver and safety equipment in the car.
    - ii. Total weight must meet or exceed the allowed prepared weight. See Appendix D.
- 2. Consumable items normally subject to wear and tear under street driving conditions may be replaced with replacement parts available from commercial retail sources. Such items include, but are not limited to, the following:
  - a. Belts
  - b. Wiper blades
  - c. Filters
- 3. Engine
  - a. All component part numbers must be identical to those contained in the engine as delivered from the factory to the US market, except as noted in the rules below.
  - b. The engine must be as delivered from factory.
    - i. Internal and external hardware (nuts, bolts, etc.) may be replaced with OE equivalent or better items performing the same fastening functions, such as the following:
      - 1) Studs
      - 2) Nuts
      - 3) Washers replacing bolts
    - ii. All hardware must be the same size, diameter, and weight as OE.
    - iii. No other modifications of any type are allowed after the air filter or before the exhaust port.
  - c. Air intakes, air filters, and air boxes may be replaced.
    - i. Intake plenums must remain stock for the engine being used; for example, a 96 M3 cannot use a 95 M3/M50 intake plenum.

- ii. Vehicles with a design that houses both the mass air meter (such as the E46, E90) and the air box as a single integrated housing may change the housing, transferring the OE air flow meter to the new air box.
      - iii. Air mass meters must remain stock.
- d. Stock fuel injection for the chassis, model, and engine must be retained, except models sold in the US market with both fuel injected and carbureted versions, which are given the following allowances:
  - i. Mechanical fuel injection may be replaced with carburetors.
  - ii. Carbureted cars may substitute up to a maximum of 40 mm downdraft.
  - iii. Jets and emulsion tubes are free.
  - iv. Modifications to the intake manifold to accept a 40 mm downdraft are allowed.
- e. Engine Management
  - i. Engine management systems other than the stock DME are not allowed.
  - ii. Replacement performance chips for OBD-I and earlier formats, as well as software downloads for OBD-II format, are unrestricted with the following exceptions:
    1. The remaining DME internal configuration must remain as stock and retain the correct model version identification and variant code.
    2. Cars with factory delivered Forced Induction must use the stock, as delivered from the factory, tune. No modifications to the engine management are allowed.
    3. External or “piggyback” devices, such as the Split Second, that either alter or modify sensor or metering signals into or out of the DME are prohibited.
    4. Substitute engine management systems such as MOTEC, EFI, or any Alpha-N system are prohibited.
- f. Machining for balancing purposes only is allowed.
- g. Pistons
  - i. All pistons, including aftermarket replacements, must be factory replacement equivalent and match factory dome, dish, valve relief depth, ring groove placement and dimensions, weight and wrist pin height, and so forth.
  - ii. Compression must meet factory specifications.
  - iii. The maximum allowable overbore is limited to the largest available factory replacement piston, not to exceed .020 inch (0.50 mm).
- h. Hoses
  - i. Any hose or line passing through any part of a bulkhead or panel must be grommeted to prevent abrasion or use an appropriate metal bulkhead fitting.
  - ii. Hoses must be properly anchored to the body or panels at least every 24 inches using protective, cushioned line clamps or factory type line retainers.
  - iii. The SAE pressure safety factor must be a minimum 4 to 1 factor

For example, if the engine develops a maximum oil pressure of 100 psi, use a hose that has a minimum 400 psi working pressure.

- iv. Hoses must be temperature rated to a minimum of 300°F.
- v. No slip-on or push-on connections are allowed except as supplied by the factory.
- i. Accusumps and Oil Systems
  - i. Accusumps are permitted.
  - ii. The oil pump and associated pickup may be replaced with an OEM bolt-on replacement.
  - iii. Dual pick-up pumps are allowed for M50, M52, S50, and S522 engines.
  - iv. Dry sump systems are not permitted.
  - v. The oil pump shaft and sprocket may be altered or replaced for reliability as long as improved reliability is the only purpose and result of the alteration.
    - 1) The bolt may be safety-wired, or the shaft and sprocket may be replaced with aftermarket units that have improved attachments (for example, splined).
    - 2) The sprocket must remain the same size and have the same number of teeth as the original part.
      - vi. The oil pan baffle and oil pan are free.
- j. Motor and transmission mounts may be replaced with aftermarket parts of any (including metallic) material but must be the same height as stock for the model year and options of the vehicle.
- k. Fittings and adaptors required to add supplementary gauges are free.
- l. Spark plugs and spark plug/ignition wires are free.
- m. Coils and coil packs must remain stock.
- n. Aftermarket water pumps that increase flow or efficiency and are of the same design type as stock are allowed.
- o. Cruise control systems may be completely removed.
- p. Emission control systems, in their entirety or in part, may be disabled or removed.
- q. Harmonic balancers are free as long as they meet OEM specifications.
- r. Under drive pulleys may be substituted for OEM water pump pulleys and alternator pulleys.
- s. Stock engine valves may be replaced by aftermarket valves as long as they retain the same dimensions and material as the stock factory parts. Keepers and retainers can also be replaced to accommodate such single groove valves.
- t. Engine Swaps
  - i. Engine swaps are permitted.
    - 1) An engine from another model of the same chassis type may be installed, as long as the converted vehicle meets all specifications of the vehicle to which it is converted.
    - 2) The class of the converted car will be based on the new engine (factory published horsepower for the new engine).

- ii. Engine swaps must retain engine management electronics as delivered from the factory; for example, an S50 engine must run an OBD I, and an S52 must run OBD II.
      - iii. An engine swap car must use the transmission associated with the donor engine.
        - 1) No other transmissions are allowed.
        - 2) No modification to the transmission or bell housing is allowed.
          - iv. Use of an unmodified alternate factory driveshaft or modified stock drive shaft to facilitate the installation is allowed.
            - 1) The stock driveshaft is what came from the receiving chassis.
            - 2) No modifications to the driveshaft that are not specifically required for the installation are allowed.
            - 3) The driveshaft configuration may not be changed.
            - 4) The driveshaft material must be as stock.
              - v. No other driveline modifications are allowed beyond those specifically allowed.
              - vi. The weight of an engine swap car must meet the greater of the weight required for the original configuration of the car as delivered from the factory:
                - 1) The weight required for the new configuration of the car based on the engine donor chassis
                - 2) The weight of the heaviest version of that chassis in its class; for example, an E36 318 or 325 chassis receiving a 2.8-liter motor must weigh as much as an E36 328
              - vii. Aftermarket wiring harnesses are permitted.
4. Exhaust System
  - a. The exhaust system may be modified or substituted.
  - b. Exhaust manifolds/headers must remain stock as delivered from the factory to the US market for the year and model car as raced, except for newer model cars equipped with catalytic converters integral to the exhaust manifold that are subject to modification as detailed below.
  - c. Catalytic converters may be removed. In cars equipped with an exhaust manifold containing a catalytic converter, the exhaust manifold may be modified from the leading edge of the factory catalytic converter backward, and the converter removed.
  - d. Exhaust configuration is free after the factory exhaust manifold/header and the exhaust must exit the bodywork only using one or more of the factory exit locations.
5. Cooling System
  - a. Any radiator may be used, providing it is mounted in the original location, maintains the same plane as the original core, and requires no body or structure modifications to install. Screens of 0.25-inch minimum mesh may be mounted in front of the radiator and/or oil cooler and contained within the bodywork.
  - b. Fans
    - i. The mechanical (engine driven) cooling fan and fan clutch may be removed or replaced.
    - ii. Electrically operated puller or pusher fans with manual or automatic actuation may be fitted.

- c. Cooling system hoses may be replaced by those of alternate materials.
- d. Thermostats and thermostat housings may be replaced by units with an alternate operating temperature or material.
- e. The coolant expansion tank may be replaced with an alternate BMW OE tank or a metallic tank of equivalent capacity and function of a BMW OE tank.
- f. Engine, transmission, and differential oil coolers are free, and must meet the following specific installation requirements.
  - i. All coolers mounted below the factory water radiator must be protected from debris intrusion with steel screening.
  - ii. Additional, non-stock parts necessary to install oil coolers are permitted.
  - iii. Parts to attach engine oil coolers are limited to those that essentially maintain stock oil filter configurations.

## 6. Suspension

- a. Shocks and Struts
  - i. Shocks and struts must use the factory stock pickup points.
  - ii. Non-adjustable, or single- or double-adjustable (compression and rebound only) shocks and struts are permitted.
  - iii. Shocks and struts that allow user changes in gas pressurization are prohibited, remote reservoir or otherwise.
- b. Nonadjustable, single, or double-adjustable shocks and struts are allowed.
  - i. Remote reservoir shocks and struts are prohibited.
  - ii. Rear shock absorbers that are originally equipped from their manufacturer with spherical bearings in their lower connection may be used.
- c. Front Camber Plates/Slotting
  - i. Adjustable front camber plates/slotting to achieve suspension settings are allowed.
  - ii. Pick-up points cannot be welded or machined for adjustment purposes.
- d. Rear Camber
  - i. Rear camber adjustment is allowed.
  - ii. Suspension components that control rear camber may be replaced with aftermarket components to provide this adjustment.
- e. Height-adjustable front coil-over setups mounted in the original location are permitted.
- f. Rear springs are free but must be mounted in the original location.
  - i. Adjustable rear spring perches may be used to adjust ride height so long as they mount in the springs' original manner and location.
  - ii. Height-adjustable rear coil overs are allowed only in cars originally factory equipped with coil-over rear suspensions.
- g. Sway Bars
  - i. Sway bar sizes, configurations, end links and end link connectors are free.
  - ii. Adjustable sway bars are allowed as long as they cannot be remotely adjusted or adjusted by the driver from inside the car.

- iii. Additional welding of sway bar pickup points and trailing arm pickup points for reinforcement and safety is allowed.
  - iv. Pickup points must remain as per factory placement.
  - v. Front sub-frame, motor mount areas, control arm pick-ups, rear lower control arms, idler arm, and steering box mounts can be strengthened for safety with additional welding.
  - vi. For those cars that can accept them without modification to the chassis, the component, or the pickup points, E36 M3 front lower control arms are allowed.
- h. Suspension bushing material is free.
- i. Bushing material does not include replacement of bushings with spherical bearings or rod ends, such as Heim ends, except as noted below.
  - ii. Solid bushings are allowed if fixed in place and allow rotation in a single plane or axis.
- i. Spherical Bearings
- i. Spherical bearings are permitted in the following components/locations:
    1. Front upper strut mounts/camber plates.
    2. Front Lower Control arm bushing.
    3. Upper and lower rear shock mounts.
    4. Rear lower control arms (both inner and outer bushing locations).
    5. Rear upper control arm (both inner and outer bushing locations).
    6. Rear Trailing arm bushing(s).
    7. Devices with spherical bearings intended to maintain the linear alignment of the rear springs throughout their expansion/compression range are allowed

## 7. Tires and Wheels

- a. Any DOT-approved, nationally marketed, generally available, “road race version” tire is allowed.
  - i. “V” or higher speed-rated tires are required for all cars, except those for which “V” rated tires are not universally available.
  - ii. In all cases, the speed rating of the tire must be equal to or greater than the speed potential of the vehicle.
- b. Rain tires
  - i. Any rain tire must be based on a DOT approved tire; for example, a grooved, DOT-approved Hoosier RS04 tire is legal.
  - ii. Any other treaded tire permitted described in 1. above may also be used as a rain tire.
  - iii. Requests for approval of any other rain tires must be submitted to the National Technical Steward.
- c. Any tire used must be, or have been (for discontinued designs), readily available for purchase by all participants on an equal basis through typical retail market outlets.

- d. Tire Tread
    - i. Shaving is permitted.
    - ii. Tread must have adequate rubber to ensure safely completing the full race session.
    - iii. Any tire deemed “unsafe” by the BMW CCA Club Racing Stewards will be disallowed and the car will be prohibited from participation until the problem is resolved to the approval of the Stewards.
    - iv. Any wheel and DOT-approved tire combination in which the top of the tread section is fully covered by the factory bodywork when viewed from above is allowed.
  - e. Spacers
    - i. Spacers may be used.
    - ii. Spacers must be hub centric, or hub extenders must be used.
  - f. Exterior fender and wheel openings must remain unmodified.
    - i. Inner fender lip rolling, flattening, or grinding at any wheel opening is allowed for tire clearance purposes, so long as the exterior profile remains unmodified.
    - ii. Fender flaring is prohibited, exception for 1600, 1800 and 2002 models, which may use BMW OEM Turbo flares or aftermarket dimensionally equivalent flares.
8. Brakes
- a. Brake calipers and caliper brackets must be of the same type and size as original for the year and model of the car. The exception is cars with factory multi-piston calipers can change to factory single-piston calipers from the same chassis series.
  - b. Caliper mountings and bushings are free.
  - c. Rotors
    - i. Brake rotors must be the same diameter and thickness as originally supplied on the car year and model as raced.
    - ii. Grooving and slotting of rotors is allowed.
    - iii. Ducting of air to rotors is allowed.
    - iv. Removal, modification, or replacement of dust shields (backing plates) is allowed.
  - d. Brake pad material is free.
  - e. Brake fluid is free.
  - f. Rubber brake lines may be replaced with braided steel over Teflon.
  - g. The emergency brakes, mechanisms, and controls may be removed.
9. Differential
- a. Ratio of the ring and pinion is free.
  - b. Non-factory limited slip of any type is allowed, including welding of the gears.
  - c. Differential mount bushings are free.
  - d. Finned, larger capacity differential covers may be used.

## 10. Transmission/Flywheel Assembly

- a. A US-spec, BMW OE transmission, as originally equipped for the chassis, model, and year must be used.
  - i. Sports classes must run the OEM BMW transmission for that chassis.
  - ii. In case of an engine swap, the donor engine must have no internal changes in gear type or design.
- b. No changes are permitted to the case or internals.
- c. The shifter mechanism may be modified or replaced.
- d. E46 M3s are allowed to run ZF 5 speed transmission, model ZF320 sourced from other BMW models.
- e. Flywheel assemblies, including clutch related items, must retain stock configuration and weight.
- f. Clutch and Pressure Plate
  - i. The clutch and pressure plate must have the same weight and the same size and number of clutch disks as originally equipped for the chassis, model, and year.
  - ii. Aftermarket replacements are allowed, but must be otherwise identical to the stock configuration and weight.

## 11. Body, Chassis, and Interior

- a. Chassis/body must be the same material as supplied by the factory.
- b. Factory delivered race cars that were homologated to race with windows in the up position, are permitted to do so. Any body repair or reinforcement must follow that as described in the factory authorized repair manual or bulletins.
- c. Fog Lights and Covers
  - i. Fog light and covers may be removed to facilitate ducting of air to brake rotors and engine.
  - ii. Fog lights may be removed and replaced with blanking plates.
- d. Headlight removal is not permitted.
- e. Seats are free subject to the safety guidelines contained in the Safety section of these rules.
- f. Steering wheels and shift knobs are free.
  - i. Quick-release steering wheel attachments are allowed.
  - ii. Steering locks must be disabled.
- g. Bumper/Air Dam Units
  - i. Aftermarket front one-piece bumper/air dam units are allowed, provided the original crash bar or one of equal integrity is maintained, or the assembly is otherwise reinforced to equal strength as the original assembly.
  - ii. The material composition of the aftermarket unit is unrestricted.
  - iii. Stock factory appearance for a variation of the specific chassis code must be retained, for example:
    - 1) E36 325 may use an M3 bumper cover but may not use an E46 M3-look cover or any other aftermarket body kit.
    - 2) E30 325i may use an E30 M3 front bumper support and cover.

h. Aerodynamic Devices

i. Front Splitters, Spoilers, and Air Dams

Aerodynamic parts allowed on the front of the car are limited to only those that came as factory standard for US market cars, excluding special production models, for the given chassis code being raced, for example:

- ii. An E36 325 can use an E36 M3 factory chin lip when using the M3 front bumper.
- iii. Neither the E36 325 or E36 M3 may use the E36 M3 Lightweight splitter assembly.
- iv. No E30 can use E30 M3 Evo parts.

i. Rear Spoilers, Wings, and Diffusers

Aerodynamic parts allowed on the rear of the car are limited to unmodified profiles of only those parts that came as factory standard for US market cars, excluding special production models, for the given year and model being raced, for example:

- i. An E30 M3 may use the stock US-model rear wing.
- ii. An E30 325i may not use an E30 M3 wing due to the modification required for fitment.
- iii. An E36 M3 may not use any rear wing/spoiler as all versions were either from special production models (M3 LTW) or dealer-installed options.

j. Modifications

- i. Modifications to the underside of the vehicle for the purpose of improving aerodynamics are not allowed (for example, diffusers).
- ii. Any aerodynamic pieces originally factory-installed on the year and model of car as raced are permitted.

k. Interior

- i. Interiors may be removed, except dash and door panels, providing the car “conforms to the spirit” of the BMW CCA Club Racing Program (it is aesthetically pleasing).
- ii. The interior includes the following items:

- 1) Carpeting
- 2) Seats
- 3) Headliner
- 4) Sound-deadening materials
- 5) Trim panels
- 6) Trunk trim
- 7) Console
- 8) Radio
- 9) Entertainment and navigation systems
- 10) Speakers
- 11) Sun visors

12) Door mechanisms

- a. The OE driver and passenger door panels may be replaced with a metallic panel with a minimum thickness of .060 inch or a comparable panel constructed of plastic or composite material, securely attached to the door.
- b. Front window glass and window actuator mechanisms may be altered or removed.

13) The dash must be intact but anything attached to it (vents, glove box, airbag cover where appropriate, and so forth) may be removed.

14) Sunroof mechanism.

- a. If the sunroof mechanism is removed, the panel must either be securely sealed (bolted, welded, or bonded) or secured in place with two retaining straps 1 inch wide and extending 3 inches beyond the sunroof opening on each side.
- b. The panel must be flush with the roofline.
- c. In cars with a sunroof cassette, the entire cassette may be removed.

- l. Any door adjacent to a seat equipped with seat belts or harness must be capable of being opened from both inside and outside the car.
- m. Wiring to components that may be removed according to the rules may also be removed.
- n. Fuses and relays for unused components may be removed.
- o. All heating and air conditioning components may be removed.
- p. Ducting to provide airflow to additional coolers (transmission, oil, and differential) is permitted.
- q. Windshield washer fluid reservoir, pump, fluid lines, and nozzles may be removed.
- r. The steering column may be mounted to the optional roll cage front cross bar (A to B as indicated on the Roll Cage Diagram), if installed.
- s. Spare tire, tools, and associated assemblies may be removed.
- t. The interior mirror may be replaced with any interior mirror meeting or exceeding the visibility of the factory part.
- u. The battery size, type, chemistry, and weight are free, but must be 12-volt.
  - i. Additional battery hold-downs are encouraged.
  - ii. Batteries must remain in their original location except for 2002 and E21 cars. E30 cars in which the battery was originally in the engine compartment may relocate the battery to the standard E30 trunk location.
- v. E36 chassis vehicles may use BMW part 51 71 8 410 212, x-brace.
- w. Engine under tray (single or multiple sectioned) may be replaced in its entirety with an aftermarket piece(s) that matches the form, fit, and function of the original piece(s).
- x. Fuel filler restrictors may be removed from the fuel filler neck.
- y. Fender well liners may be removed.
- z. All E30 chassis cars may use the factory E30 convertible front reinforcements.
- aa. Fuel Pump
  - i. A second fuel pump is allowed.

- ii. A mechanical fuel pump may be replaced with an electrical fuel pump provided that it is wired so that it is controlled by the ignition system, to ensure shut down in the case of an accident requiring electrical cut-off.

12. Fuel Cells are allowed. See safety section for applicable rules.

13. Fuel

- a. The engine must run on the fuel type consistent with the original BMW factory engine design (either gasoline or diesel).
- b. Only 93 or less octane pump fuel is allowed.
- c. Ethanol (other than that normally added to gasoline available to the public), methanol, toluene, nitro methane, super oxygenated fuels, nitrous oxide, and/or custom-mixed fuels are not allowed.

14. Data Acquisition

- a. Data acquisition devices must be used for information gathering **only**.
- b. Additional data acquisition devices, including gauges, are permitted in Sports classes, as long as the driver is not able to adjust any setting on the vehicle at any time while the car is in motion.
- c. The OE gauge panel (instrument cluster) must remain in place.
- d. Additional devices may be located anywhere within the cockpit, including in front of the stock gauges.

15. **Prepared Classes**

- 1. Prepared classes allow participation with a higher level of modification than the Sports classes but remain in keeping with the spirit of the original vehicle. BMW models with factory installed Forced Induction will not be allowed in Prepared classes. The extreme tunability of the powerplants is not in the spirit of the prepared class rules. BMWs with a prepared level of preparation and Forced Induction are welcome in the PWR class.
- 2. Prepared classes are based on the stock class of the chassis and model; for example, a chassis/model classed as a J class car in Sports will be a J class car in Prepared.
- 3. Prepared class race cars are weighed with the driver and safety equipment in the car and total weight must meet or exceed the allowed prepared weight published herein.
- 4. All Sports class improvements are also allowed in Prepared classes.

5. Engine

a. Intake System

i. Carburetors

- 1) Four-cylinder engines originally equipped with carburetion are permitted two carburetors.
- 2) Engines with six or more cylinders that were originally equipped with carburetion are permitted three carburetors.
- 3) Carburetion in excess of the limits of 1) and 2) above will result in the car being moved up one class.
- 4) Modifications or changes to the intake manifold to accept additional carburetor(s) are allowed.

ii. Throttle bodies, including the connector between the plenum and the throttle body, are free, but must remain in the original configuration

BMW CCA Club Racing Rules 2026 – 1/30/2026

For example, multiple throttle bodies may not be substituted for a single throttle body.

- iii. Intake plenums may be swapped and must be OE BMW from the chassis generation being used.

For example, a 96 M3 can use a 95 M3 M50 plenum, but an E46 325 with an M54 engine cannot backdate to an M50 plenum.

- iv. Fuel injection air-metering devices must remain in the stock configuration and operation.

- 1) Alternate air flow meters (AFM) and mass airflow meters (MAF) that retain the same metering method (air flap, hot wire, or hot film) may be used.
- 2) AFM may not be substituted for an MAF or vice versa.
- 3) The wiring and connector for the air-metering device may be altered to allow the use of an alternate legal air-metering device.

b. Camshafts

- i. Camshaft lift and duration may be changed from stock.
- ii. Cam gears, Vanos shims, and valve seats and springs are free.
- iii. Alternate valve retainers of the same material as stock and equal or heavier weight than stock is allowed.
- iv. Cam timing is free.

c. Non-OE ignition boxes are allowed for distributor-based engines, such as an MSD box.

d. OBDII-equipped cars may retrofit engine electronics to the pre-OBDII factory system that was available on models with the same engine type.

- i. Vehicles originally equipped with OBDI engines may use an engine from an OBDII car and keep the original electronics to the receiving chassis.
- ii. For example, E36 325 receiving an M52B28 motor and retaining the original OBDI chassis electronics.

e. Engine Management

- i. Engine management systems other than the stock ECU are not allowed.
- ii. ECU software is free as long as the ECU configuration remains stock.
- iii. Devices that alter, condition, or otherwise modify the inputs to the ECU or the signals from the ECU are prohibited.
- iv. Alpha-N programming and DTA, Motec, EFI, Split Second, and all other replacement or "piggyback" engine management systems are prohibited.

f. Pistons

- i. All pistons must be factory replacement equivalent and match factory dome, dish, valve relief depth, ring groove placement, weight, and wrist pin height, and so forth.
- ii. Compression must meet factory specifications.
- iii. The maximum allowable overbore is limited to the largest available factory replacement piston, not to exceed .040 inch (1.00 mm).
- iv. The compression ratio may be changed only within the tolerances affected by resurfacing for trueness and must be within factory tolerances.

- g. Fuel injectors are free.
- h. Exhaust headers are free.
- i. The power steering reservoir may be replaced, and associated lines may be replaced with braided steel lines using AN fittings.
- j. Oil Filters
  - i. Oil filter housings may be replaced with alternate or aftermarket oil filter housings or oil distribution blocks.
  - ii. Remote oil filters may be used with alternate or aftermarket oil distribution blocks that do not incorporate an oil filter housing.
- k. E36 Engine Swaps
  - i. An “E36 Chassis Swap” occurs when a motor and transmission from an E36 standard variant (not E36/7 Z3) is placed within an E36 chassis that is different from the one it was placed in when delivered from the factory.
  - ii. The class of the chassis swap car will be based upon the engine.
  - iii. A chassis swap car may update/backdate with chassis-specific components, including using M model components, such as suspension or sub-frame.
- l. The weight of a chassis swap car must meet the greater of the following:
  - i. The weight required for the original configuration of the car as delivered from the factory
  - ii. The weight required for the new configuration of the car based on the donor chassis
  - iii. The weight of the heaviest version of that chassis in its class; for example, a car with an M52B28 engine installed in an E36 318 or 325 chassis receiving must weigh as much as an E36 328.

## 6. Suspension

- a. Upgrading to suspension components from an M series chassis within the E36 chassis family (that is, E36M3 to E36) is allowed.
- b. Vehicles with stock four-lug hubs may be upgraded to BMW five-lug hubs.
- c. Quicker-ratio units for steering boxes or rack and pinion steering assemblies may be used provided they are BMW components.

## 7. Brakes

- a. Rotors are free, except carbon rotors are not allowed.
- b. Calipers are free with the following limitations:
  - i. Four-piston maximum
  - ii. Two-piece design
  - iii. One caliper per wheel
- c. Master Cylinders
  - i. The number of master cylinders must be as supplied by the factory, except that early production cars (such as the 1600, 1800, and 2002) may update to a tandem master cylinder for the safety of the dual-circuit system.

- ii. Master cylinders may be modified or replaced to increase volumetric flow; however, the unmodified stock fluid reservoir and brake booster must be retained.
    - d. Brake drums are free (for example, 1600/2002 and 320 models).
    - e. Upgrading to M-specific components is allowed on all non-M cars of the same generation (for example, E36 325 may use E36 M3-fitment brake parts, but not E46 M3-specific parts unless otherwise categorically allowed above).
    - f. BMW supplied Teves (ATE) Mk60 stand-alone ABS systems may be retrofitted. Only non-M Mk60 systems as supplied by BMW on E46 non-M cars may be utilized. Retrofitted hydraulic lines, fluid reservoirs and wiring as required for these systems are allowed.
8. Transmission/Flywheel Assembly
- a. The flywheel is free except that it must be constructed of ferrous material and/or aluminum.
  - b. The clutch disk may be lightened or replaced with alternate materials.
  - c. Replacement Clutch Disks
    - I. Replacement clutch disks must be no smaller than 7 inches in diameter
    - II. No more than two clutch disks are allowed.
  - d. The pressure plate may be replaced but must use the original equipment mounting holes.
  - e. The Prepared class must run the OEM BMW transmission for that chassis (converted chassis) with no internal changes in gear type or design. E46 M3s are allowed to run ZF 5 speed transmission, model ZF320 sourced from other BMW models.
9. Body, Chassis, and Interior
- g. Openings in the front air dam/bumper cover to provide for ducting to additional coolers (oil, transmission, and differential) are permitted.
  - h. Rear spoilers and wings are free providing they meet the following:
    - i. They do not exceed maximum body width.
    - ii. They are no higher than the roofline.
    - iii. They do not extend more than 2 inches past the farthest part of the rear bumper as viewed from above the car.
    - iv. Vehicles with a roofline that extends to the rear for the full extent of the body may have these devices extend no more than 3 inches above the roofline.
  - i. Front splitters are free providing they meet the following:
    - i. They do not exceed maximum body width.
    - ii. They do not extend rearwards past the front axle centerline.
    - iii. They do not extend more than 3 inches past the farthest part of the front spoiler or bumper as viewed from above and follow the general outline of the spoiler.
    - iv. Installed devices must be consistent with the spirit of the original design of the car such as those presented by aftermarket sources.
    - v. Dive plates are allowed.

- j. No aerodynamic device may be installed that has the capability of being controlled, altered, or adjusted by the driver or by any other means while the car is in motion.
- k. Front windshields may be replaced with polycarbonate of a minimum 6 mm thickness.
  - i. Front windshield retaining clips or straps are required for non-glass windshields.
  - ii. A minimum of four exterior retaining clips (two top and two bottom) or two exterior retaining straps and two interior windshield supporting bars are required.
  - iii. If an edge of a polycarbonate windshield is not accessible for measurement, a 0.125-inch diameter inspection hole must be drilled near a bottom corner of polycarbonate windshields to allow confirmation of thickness.

10. Data Acquisition – The stock gauge panel (instrument cluster) may be removed in whole or in part.

#### 11. Fuel

- a. The engine must run on the fuel type consistent with the original BMW factory engine design (either gasoline or diesel).
- b. Selection and mixing of commercially available leaded or unleaded fuel and octane ratings are free with the exception of E85/Flex Fuel which is not allowed due to the high percentage of Ethanol and related fire safety issues.
- c. Commercially available octane boosters are allowed.
- d. Ethanol (other than that normally added to gasoline available to the public), methanol, toluene, nitro methane, super oxygenated fuels, nitrous oxide, and/or custom-mixed fuels are not allowed.

#### 12. Modified Class

##### 1. Class Intensions

##### a. Modified

- i. The Modified classes are for race cars with a still higher level of modification than the Prepared classes.
- ii. Modified classes require use of a BMW engine.
- iii. All Sport and Prepared class improvements are also allowed in the Modified classes.
- iv. Class for competition will be based on engine displacement.

2. Metallic treatments are permitted such as plating and/or coating.

##### 3. Engine

- a. The car must retain a BMW OE engine block and head.
  - i. Schnitzer heads are allowed on M10 engines.
  - ii. All other changes, relocations, substitutions, alterations, and modifications are free.
  - iii. Fuel type restrictions listed in the Sport class section remain in place.
- b. Engine/drive train configuration must remain as stock.
- c. Front engine rear drive cars may not relocate the engine to the rear, etc.

BMW CCA Club Racing Rules 2026 – 1/30/2026

- d. Turbocharging/Supercharging – For the purpose of class determination, engines with turbo charging or supercharging must have the actual engine displacement increased by a factor of 1.5 (150%), regardless of boost level.
- e. Oil Systems
  - i. Dry sump oiling systems are allowed.
  - ii. The oil tank(s), cap(s), oil filter(s), and any fittings attached thereto must be isolated by a metal bulkhead(s) so that in the event of any spillage, leakage, or failure, oil will not reach the driver.
- f. Exhaust is free, including side exit.
- g. Effective January 1, 2026, Power limits for the CMOD and BMOD classes are as follows:
  - i. CMOD – Maximum RWHP (as measured on a Dynojet Dyno) – 430.
  - ii. BMOD – Maximum RWHP (as measured on a Dynojet Dyno) – 530.
- 4. Suspension
  - a. The suspension is free.
- 5. Tires and Wheels
  - a. Any tire and wheel combination meeting the safety requirements of the BMW CCA Club Racing program technical inspectors is allowed.
  - b. Any tire used must be, or have been (for discontinued designs), readily available for purchase by all participants on an equal basis through typical retail market outlets.
  - c. Tire and wheel packages must be completely covered by the bodywork and have sufficient clearance to prevent rubbing that could be considered dangerous.
  - d. Non-DOT approved race tires (slicks), including rain tires, are allowed.
- 6. Brakes
  - a. Brakes are free.
    - i. Non-metallic rotors are not allowed.
    - ii. Cockpit-adjustable brake biasing is allowed.
  - b. Brake lights are required and must be as bright and as easily seen as stock brake lights.
- 7. Differential is free.
- 8. Steering is free.
- 9. Transmission Assembly
  - a. Modified cars may use any BMW OE transmission from any chassis or non-OEM transmissions, sequential gear boxes, dog-ring gear changes, or any other internal changes in gear type or design.
  - b. Flywheel lightening or replacement is allowed.
    - i. Modified cars must use a ferrous and/or aluminum flywheel.
  - c. Clutch, pressure plate, and actuating mechanisms are free.
- 10. Drive Shaft
  - a. Carbon fiber driveshafts are allowed.
- 11. Body, Chassis, and Interior

- a. The following may be replaced with parts of alternate material(s) and design, provided their shape maintains the recognizable external features of the standard BMW automobile:
  - i. Doors
  - ii. Fenders, which may be flared or boxed to cover wheels and tires
  - iii. Hood
  - iv. Bumpers
  - v. Side skirts
  - vi. Rear fascia
  - vii. Deck lids
- b. Non-critical sheet metal (spare tire wells, etc.) may be removed.
  - i. Removal may not be primarily intended to provide aerodynamic benefit, except between the front of the car and the front axles, and between the rear of the car and the rear axles.
  - ii. Any sound deadening or insulation may be removed, except as required around a stock fuel tank when it is retained.
- c. Body seams may be fully welded, or stitch welded.
- d. Partial tube-frame construction is allowed.
  - i. Construction must be based upon factory chassis.
  - ii. VINs on the cowl and doorframe must be in place, or the door sill tag must be intact if originally supplied.
  - iii. The A, B, and C pillars must be OE both in angles, length, and location.
  - iv. Roof must be OE.
  - v. OE rocker panels must be used.
- e. Cutting of non-stock openings and removal of headlights is allowed.
- f. Ducting for any purpose is allowed.
- g. Aerodynamics
  - i. Underbody aerodynamic aids, other than those stock to the model and chassis, are not permitted between the front and rear axles.
  - ii. Under trays are allowed between the front of the car and the front axles, and rear diffusers/venturi devices are allowed between the rear axle and the rear of the car.
  - iii. Rear underbody aerodynamics must terminate no further back than 1 inch past the rear of the stock bumper location as viewed from above.
  - iv. If under-car fuel tanks have been removed, a panel that duplicates the bottom profile of the stock tanks may be attached and must not extend past the location of the stock tanks more than a small amount required to affix the panels.
- h. Splitters are free, provided they meet the following:
  - i. They do not exceed maximum body width
  - ii. They extend no further forward than 4 inches from the stock front bumper as viewed from above.

- iii. They are subject to the underbody aerodynamics restrictions.
- i. Wings are free, provided they meet the following:
  - i. They do not exceed maximum body width.
  - ii. They are no higher than a line parallel to the ground at the highest point of the roofline.
  - iii. They extend no further than 16 inches behind the rear bumper as viewed from above.
  - iv. Vortex or velocity generators that do not violate these restrictions are permitted.
  - v. Vehicles with a roofline that extends to the rear for the full extent of the body may have these devices extend no more than 3 inches above the roofline.
- j. Windows
  - i. Front windshield can be replaced as outlined in Prepared.
  - ii. Front side windows may be removed. Rear side and rear windows can be replaced with alternate material but must remain transparent.
  - iii. Vent holes are permitted in polycarbonate windows.
- k. Roof Panels
  - i. The moveable sunroof panel may be replaced by a panel of any metallic or composite material.
  - ii. Chassis that have alternate OE roof panels may use any of the OE panels or exact replicas. The roof must be installed according to factory specifications.
- l. Batteries are free and may be replaced and located anywhere in the chassis. Wet-cell batteries located in the passenger compartment must be contained in a marine-style box.
- m. Removal of the interior is allowed providing the car “conforms to the spirit” of the BMW CCA Club Racing program; that is, it is aesthetically pleasing.
- n. All wiring is free provided required components (such as brake lights) function as required.
- o. External mirrors may be replaced.

## 12. Fuel Cells

- a. Fuel cells are required.
- b. For cars with factory stock fuel tanks located forward of the rear axle (such as the E21, E30, E36 and E46 chassis), the stock fuel tank may be used.

## 13. Spec 36™ Class

1. The Spec E36 class specifies a set of E36 chassis, six-cylinder race cars that are prepared to a uniform level.
2. The modifications required or allowed are intended to produce a fun, fast race car that feels like a race car, yet remains relatively inexpensive to prepare and maintain.
3. BMW CCA Club Racing may, from time to time, make adjustments to these specifications to balance competition.
4. The Spec E36 class is dedicated to competition between drivers, not their ability to prepare a car.
  - a. Any modifications not specifically listed within the class rules are not allowed.

- b. Any variances found at the track will result in severe penalties as allowed.
  - c. Any rules loopholes will be closed quickly.
  - d. This is not a class in which to exploit the rules; strict adherence to the rules is expected without exception.
5. Specific rules for Spec E36 are available on the BMW CCA Club Racing website under the section “General Information > for the racer” at <http://www.bmwccaclubracing.com/SpecE36>.
6. E30 M3 Touring Car Class
- 1. The E30 M3 Touring Car Class recognizes the special status that the E30 M3 has in Group A and N Touring Car history, being the most successful chassis, and its significance in launching the lineage of BMW’s mass production M cars.
    - a. This class is for BMW CCA Club Racers wishing to build a true race car in the spirit of the early Group A and Group N E30 M3 race cars.
  - b. The focus of the E30 M3 Touring Car Class is on race car handling, with tightly limited engine modifications.
2. The E30 M3 Touring Car Class is open only to E30 M3 chassis race cars that are prepared to a strict set of guidelines.
- a. The modifications permitted are intended to produce a fun, fast club-level race car that feels like a pro-level race car, allows the driver and crew to adjust its handling like a pro race car, yet remains relatively inexpensive to prepare and maintain.
- b. Weight
- i. E30 M3 Touring Car Class race cars are weighed with the driver and all personal safety gear in the vehicle.
  - ii. Total weight must meet or exceed the minimum permitted E30 M3 Touring Car Class published weight.
3. E30 M3 owners who wish to prepare their cars for those classes to which the E30 M3 is normally assigned, may still do so. It is not mandatory that racers classify their E30 M3s in the E30 M3 Touring Car Class.
4. E30 M3 Touring Car Class rules stand alone and do not use allowances from the Sport or Prepared classes unless specifically noted herein.
- a. Roll cages must meet the requirements specified for the Prepared classes.
  - b. All references to “stock” and “factory” refer to the U.S. specification E30 M3, unless used specifically in the context of the EVO II and EVO III versions of the E30 M3.
5. Consumable items normally subject to wear and tear under street driving conditions may be replaced with replacement parts available from commercial retail sources. Such items include, but are not limited to, the following:
- a. Belts
  - b. Wiper blades
  - c. Filters
6. Cryogenic treatment and aftermarket coatings of any part or component are permitted.
7. All requirements from the General and Safety sections of this rulebook must be followed.
8. The BMW CCA Club Racing Stewards reserve the right to test any car for conformance at any time.

9. Engine
  - a. All component part numbers must be identical to those contained in the engine as delivered from the factory to the US market, except as noted in the rules below.
  - b. The engine must be as delivered from factory, except as noted in the rules below.
    - i. Internal and external hardware (nuts, bolts, etc.) may be replaced with OE equivalent or better items of the same weight and performing the same fastening functions, such as the following:
      - 1) Studs
      - 2) Nuts
      - 3) Washers replacing bolts
    - ii. All hardware must be the same size, diameter, and weight as OE.
  - c. No other modifications of any type are allowed after the air filter or before the exhaust port, except as noted in the rules below.
  - d. Air Intakes, Air Filters, and Air Boxes
    - i. The stock air box and intake must be retained.
    - ii. The air filter panel is free.
    - iii. The ducting before the air filter housing, including the lower air box, donut, and snorkel, is free.
  - e. Stock fuel injection, including fuel injectors, for the chassis, model, and engine must be retained.
  - f. Engine Management
    - i. Engine management systems other than the stock ECU are not permitted.
    - ii. ECU programming, contained exclusively on a single integrated circuit central processing unit, commonly called a chip, is free as long as the ECU remains stock in every other way.
    - iii. Devices that alter condition or otherwise modify the inputs to the ECU or the signals from the ECU are prohibited.
    - iv. Alpha-N programming and DTA, Motec, EFI, Split Second, and all other replacement or "piggyback" engine management systems are prohibited.
  - g. Camshafts
    - i. Camshafts may be changed from stock to BMW factory or any aftermarket camshafts provided they do not exceed the lift/duration specifications of 11.5 mm/284 degrees intake and 11.3 mm/276 degrees exhaust camshafts, respectively.
    - ii. Valve springs are free.
    - iii. Alternate valve retainers of the same material as stock and equal or heavier weight than stock are permitted.
    - iv. Cam Gears
      - 1) Any BMW factory cam gear or an exact replica of a BMW factory cam gear may be used.
      - 2) Adjustable cam gears are permitted.

- v. No other internal engine changes, including cylinder head porting and/or polishing of any kind, are permitted.
- h. Machining for balancing purposes only is permitted and must be within factory tolerances.
- i. Pistons
  - i. Stock factory specification pistons or factory EVO II specification pistons for the 2.3-liter S14 engine are permitted.
  - ii. Compression ratio must not exceed 11.0:1.
  - iii. Aftermarket pistons are permitted, but must match factory dome, dish, valve relief depth, ring groove placement, skirt, and wrist pin height for either U.S. E30 M3 factory OE pistons or factory E30 M3 EVO II pistons.
  - iv. Compression must meet factory replacement specifications and may be changed only within the tolerances affected by resurfacing for trueness.
  - v. The maximum allowable overbore is limited to .040 inch.
  - vi. Aftermarket ferrous rods no lighter than 560 grams (including rod bolts, excluding rod bearings) are allowed.
- j. Accusumps and Oil Systems
  - i. Accusumps are permitted.
  - ii. Oil pan baffle and oil pan are free.
  - iii. Engine Oil Coolers
    - 1) Engine oil coolers are free.
    - 2) Coolers must meet the following specific installation requirements:
      - a) All coolers mounted below the factory water radiator must be protected from debris intrusion with steel screening.
      - b) Additional plumbing is permitted for engine oil coolers, but the oil filter must remain in the stock location.
    - 3) Additional plumbing is permitted for engine oil coolers, but the oil filter must remain in the stock location.
- k. Motor and Transmission Mounts
  - i. Motor and transmission mounts may be replaced with aftermarket parts of alternate material but must be the same height as stock.
  - ii. Aftermarket transmission mount stiffening devices are permitted.
- l. Spark plugs and plug wires are free.
  - i. Ignition systems must remain stock.
  - ii. The coil must be as supplied by the factory.
- m. Water Pumps
  - i. Factory or aftermarket metallic thermostat housings are permitted.
  - ii. Aftermarket engine-driven water pumps that directly replace the OE pump are permitted.
- n. Radiators are free provided they are mounted in the same plane as the factory radiator.
  - i. Cooling system hoses may be replaced by those made of alternate materials.

- ii. Plastic shrouds above and behind the radiator may be removed.
  - o. The mechanical (engine-driven) cooling fan may be removed or replaced with an electrical fan using manual or automatic switching.
  - p. Cruise control systems may be removed or disabled.
  - q. Under drive pulleys are permitted.
  - r. The power steering pump may be removed, and stock steering rack may be plugged to convert to manual steering.
  - s. Adjustable fuel pressure regulators are permitted.
  - t. An electrical cut-off switch, as defined in the Safety Section, is required.
  - u. Fuel type restrictions are the same as those listed in the Stock class section.
  - v. Engine Substitution
    - i. The 2.5-liter S14 engine may be used as a substitute for the 2.3-liter S14 engine.
    - ii. The stroke is limited to 87 mm.
    - iii. The bore is limited to 95 mm.
    - iv. The engine must be compliant with all other existing rules for the 2.3-liter M3T engine.
    - v. Weight
      - 1) Vehicles using the 2.5-liter S14 engine will have an additional 100 lbs. weight penalty.
      - 2) Vehicles need to indicate the additional weight penalty with a "100 +" decal on the right lower corner of the windshield.
  - w. Engine Prep
    - i. M3T S14 engines may be prepared with a 2.0-liter crank and appropriate rods/pistons.
    - ii. The engine must be compliant with all other existing rules for the 2.3-liter M3T engine.
    - iii. Weight
      - 1) Vehicles may run up to 100 lbs. under the listed prepared weight.
      - 2) Vehicles need to indicate the underweight allowance with a "100-" decal on the right lower corner of the windshield.
10. Suspension
- a. Front Camber Plates/Slotting
    - i. Adjustable front camber plates/slotting to achieve suspension settings are allowed.
    - ii. Pick-up points cannot be welded or machined for adjustment purposes.
  - b. Rear Camber
    - i. Rear camber and/or toe adjustment is permitted.
    - ii. Suspension bushings may be replaced with eccentric versions and rear sub-frame can be modified with slots that allow rear camber adjustment.

- c. Height-adjustable front coil-over setups mounted in the original location are permitted.
- d. Rear Springs
  - i. Rear springs are free but must be mounted in the original location.
  - ii. Adjustable rear spring perches may be used to adjust ride height as long as they mount in the springs' original manner and location.
- e. Springs and spring rates are free.
- f. Sway Bars
  - i. Sway bars are free but must use stock mounting locations.
  - ii. Sway bars cannot be remotely adjustable or adjustable by the driver inside the cockpit.
  - iii. Sway bar link connectors are free.
  - iv. Reinforcement of sub-frame and sway bar pickup points for safety purposes is permitted and strongly recommended.
- g. Bushings
  - i. Suspension bushing material is free.
  - ii. Bushing material does not include replacement of bushings with spherical bearings or rod ends such as Heim ends except as noted f. Spherical Bearings below.
  - iii. Solid bushings are allowed if fixed in place and allow rotation in a single plane or axis.
- h. Spherical Bearings – Spherical bearings are permitted in the following components:
  - i. Front upper strut mounts
  - ii. Upper and lower rear shock mounts
  - iii. Rear lower arm controls
  - iv. Camber plates
- i. Any bolt-in shock tower brace is allowed. Welded-in rear shock tower braces are allowed.
- j. Adjustable “bump steer” correction kits are free.
- k. Aftermarket replacement front lower control arms are allowed provided they meet the following:
  - i. They do not alter geometry.
  - ii. They are made of similar material as the OEM control arms.

## 11. Tires and Wheels

### a. Tires

- i. Any wheel and DOT-approved tire combination that fits under the fenders is permitted.
- ii. “V” or higher speed-rated tires are required.
- iii. Any tire must be, or have been (for discontinued designs), readily available for purchase by all participants on an equal basis through typical retail market outlets.
- iv. Any rain tire must be based on a DOT-approved tire, including custom grooved tires based on an otherwise DOT approved tire.

BMW CCA Club Racing Rules 2026 – 1/30/2026

- 1) Any other treaded tire permitted under paragraph a. may also be used as a rain tire.
- 2) Requests for approval of any other rain tires must be submitted to the National Technical Steward.
  - v. Hoosier Dirt Stockers are not permitted.
  - vi. Tread must have adequate rubber to ensure safely completing the full race session.
  - vii. Tire tread shaving is permitted.
  - viii. Any tire deemed unsafe by the BMW CCA Club Racing Stewards will be not be permitted and the car will be prohibited from participation until the problem is resolved to the satisfaction of the Stewards.

b. Wheels

- i. Wheel width and offset is free.
  - ii. Wheel type and style is free providing the wheel meets or exceeds factory safety specs.
- 1) Spacers may be used to allow wheels with offset differences.
  - 2) Spacers must be hub centric or hub extenders must be used.
    - iii. Fender and wheel openings must remain unmodified except that rolling under, flattening or grinding any interior lip on a wheel opening is permitted for tire clearance purposes.
    - iv. Fender flaring is prohibited.
    - v. Wheel bolts may be replaced with studs.

12. Brakes

- a. Calipers must be BMW OEM single-piston sliding design (from any model).
  - i. Only one caliper per wheel is permitted.
  - ii. Caliper mountings and bushings are free.
- b. Rotors
  - i. Rotors are free but must be one-piece or fixed two-piece.
  - ii. Carbon rotors are not permitted.
  - iii. The rotors must fit within wheels that comply with section 11 Tires and Wheels, b. Wheels above.
- c. Brake pad material is free.
- d. Master Cylinders
  - i. The number of master cylinders must be as supplied by the factory.
  - ii. Master cylinders may be modified to increase volumetric flow.
- e. Cockpit-adjustable brake bias control is not permitted.
- f. Ducting of air to front rotors is permitted. The addition of duct plates to the front hub or strut is permitted.
- g. Dust Shield
  - i. Removal or modification of dust shields is permitted.

- ii. Alternate dust shields to allow ducting are permitted.
  - h. Brake fluid is free.
  - i. Flexible brake lines may be replaced with braided steel over Teflon lines, and are strongly recommended.
  - j. Emergency brakes, mechanisms, and controls may be removed.
13. Differential
- a. Ratio of the ring and pinion is free.
  - b. Non-factory limited slip of any type is permitted, including welding of the gears and/or modification of lockup characteristics including ramp angles and lockup percentages.
  - c. Differential Coolers
    - i. Differential coolers are free.
    - ii. Finned, larger capacity differential covers may be used.
  - d. Differential mount bushings are free.
14. Transmission and Flywheel Assembly
- a. BMW OE Transmission
    - i. A BMW OE transmission as originally equipped for the U.S. or European market, or factory alternate transmission designed for the chassis/engine/model/year must be used.
    - ii. No alternate gear ratios or changes to the case or internals are permitted.
  - b. The flywheel is free except that it must be constructed of ferrous material and/or aluminum.
  - c. Clutch
    - i. The clutch may be lightened or replaced with one made from alternate materials.
    - ii. The clutch and pressure plate must be the same size and number of clutch disk(s) as originally equipped for the chassis, model, and year.
    - iii. Lightweight pressure plates are permitted.
  - d. Shifter mechanisms may be modified or replaced.
15. Body, Chassis, and Interior
- a. Chassis/body, with the exception of spoilers and wings, must be the same material as supplied by the factory.
    - i. E30 M3 EVO III front fenders are NOT permitted.
    - ii. Grp A exterior mirrors are not permitted.
  - b. Any body repair or reinforcement must follow procedures as described in the factory authorized repair manual or bulletins.
  - c. Lights
    - i. Fog lights and covers may be removed to facilitate ducting of air to front brake rotors, coolers, and engine.
    - ii. The headlight units must remain in place and be functional.
    - iii. Protective headlight covers are permitted.

- d. Seats
  - i. The driver's seat may be any racing seat that meets BMW CCA Club Racing safety standards.
  - ii. The passenger seat may be removed.
  - iii. Rear seats must be removed.
- e. Steering Wheel
  - i. Steering wheels and shift knobs are free.
  - ii. Quick-release steering wheel attachments are permitted.
  - iii. It is recommended that steering locks be disabled.
- f. Spoilers, Splitters, and Wings
  - i. Front spoilers, splitters and wings must be as originally equipped for the E30 M3 model, including the EVO II and III series, or aftermarket units that are identical to factory EVO II and EVO III parts in terms of shape, height, or adjustability.
  - ii. Aftermarket front, one-piece replica bumper/air dam units are permitted provided it meets one of the following:
    - 1) The original crash bar or one of equal integrity is maintained.
    - 2) The assembly is otherwise reinforced to equal strength as the original assembly.
    - iii. No other aerodynamic devices may be installed.
- g. Modifications to the underside of the vehicle for the purpose of improving aerodynamics are not permitted.
- h. Interior
  - i. The interior, except for the dash, may be removed.
  - ii. The interior includes carpeting, seats, headliner, sound-deadening materials, trim panels, trunk trim, door panels, console, glove box, rear package shelf, entertainment and navigation systems, speakers, sun visors, central locking system, door lock and window mechanisms, and the sunroof mechanism.
  - iii. Factory E30 convertible frame reinforcements are permitted.
  - iv. Sunroof Mechanism Removal
    - 1) If the sunroof mechanism is removed, the OE panel or a replacement of like material or metal, must either be securely sealed (bolted, welded, or bonded) or secured in place with two retaining straps at least 1-inch wide and extending 3 inches beyond the sunroof opening on each side.
    - 2) The panel must be flush with the roofline.
  - v. Doors
    - 1) The OE front driver and passenger door decorative panels may be replaced with 0.060-inch aluminum or a comparable material, including carbon fiber or similar composite materials, securely attached to the door.
    - 2) Window glass and window actuator mechanisms may be altered or removed.
    - 3) Both front doors must be capable of being opened from both inside and outside the car.

- 4) Integrated door bars may be removed.
  - vi. Windows
    - 1) Windows may be replaced with polycarbonate.
    - 2) Driver and passenger door windows may be removed.
    - 3) Windshields may be replaced with polycarbonate of a minimum 6 mm thickness.
      - a) Front and rear windshield-retaining clips or straps are required for non-glass windshields.
      - b) A minimum of four exterior retaining clips (two at top and two at bottom) or two exterior retaining straps and two interior windshield- supporting bars are required.
      - c) If an edge of a polycarbonate windshield is not accessible for measurement, a .125-inch diameter inspection hole must be drilled near a bottom corner of polycarbonate windshields, or an appropriately sized caliper must be supplied by the driver, to allow confirmation of thickness.
      - d) Vent holes and ducts are permitted in polycarbonate windows.
        - vii. The original factory wiring harness must be retained, but unused portions of the wiring may be removed.
        - viii. Ballast
          - 1) Any ballast to meet weight must be placed entirely in one or more of the following places:
            - a) Passenger side front
            - b) Rear floor area
            - c) Spare tire well in the trunk
          - 2) Ballast must be securely bolted to the chassis.
          - 3) Each segment of ballast must be fastened with a minimum of two bolts (metric M12/Grade 10.9 or SAE ½-inch/Grade 8 or higher) and corresponding positive lock nuts, and with a large diameter, load-distributing washers.
            - ix. Heating and Air Conditioning Components
              - 1) All heating and air conditioning components may be removed.
              - 2) It is suggested, but not required, that the defroster remain functional.
                - x. Spare tire, tools, tool kits, and associated assemblies may be removed.
                - xi. The interior mirror may be replaced with any interior mirror meeting or exceeding the visibility of the factory part.
                - xii. The battery size, type, chemistry, and weight are free, but must be 12-volt units. Additional battery hold-downs are encouraged. Batteries must be located in the stock right side trunk well location.
                - xiii. All unused and unnecessary brackets may be removed. Unibody panels and other chassis components may not have material removed for the purposes of lightening the car.
                - xiv. Undercoating and sound-deadening materials outside the interior may be removed.

## 16. Fuel Tank/Fuel Cell

- a. Fuel Cells are allowed. See safety section for applicable rules.
  - b. Fuel Starvation Kits that include a second, in-tank fuel pump and/or additional plumbing may be installed, provided their only purpose is to prevent low fuel level starvation problems.
17. Data Acquisition
- a. Data acquisition devices, including gauges, are permitted, as long as the driver is not able to adjust any setting on the vehicle at any time while the car is in motion.
  - b. These devices are to be used for information gathering ONLY.
  - c. Stock Gauge Panel
    - i. The stock gauge panel (instrument cluster) may be removed in whole or in part.
    - ii. If retained none of the devices contained within it are required to remain functional.
18. Spec E30 Class
1. The Spec E30 class specifies a set of E30 chassis, six-cylinder race cars that are prepared to a uniform level.
  2. The modifications required or allowed are intended to produce a fun, fast race car that feels like a race car.
  3. The Spec E30 is a class dedicated to competition between drivers, not their ability to prepare a car.
  4. Any modifications not specifically listed within the class rules are not allowed. Any variances found at the track will result in severe penalties as allowed.
  5. Vehicle safety equipment must meet or exceed BMW CCA Club Racing published safety requirements.
  6. Published Rules and Regulations
    - a. The Spec E30 rules and regulations are published at [www.spece30.com](http://www.spece30.com).
    - b. Competitors must have a copy of the regulations (electronic versions acceptable) available along with any technical bulletins.
7. Spec Mini
1. The Spec Mini class allows Mini Cooper non-S version race cars prepared to SCCA B-Spec/T4 rules to race in BMW CCA Club Racing in a points eligible class.
  2. S-version and JCW Mini Coopers are not eligible.
  3. Rules
    - a. Preparation rules and weights mirror the SCCA B-Spec/T4 rules as published in the most recent online version of the SCCA GCR including any technical bulletins.
    - b. Competitors must have a copy of the SCCA GCR and any technical bulletins (electronic versions acceptable) available.
  4. Vehicle safety equipment, with the exception of roll cages, must meet or exceed BMW CCA Club Racing published safety requirements, as listed in section III. Safety.
  5. Roll cage specifications must mirror SCCA B-Spec rules exactly.
  6. The base weight for all model years will be the same weight as the 2007-2010 model years.

7. BMW CCA Club Racing reserves the right to make competition adjustments to encourage level competitiveness.
8. Spec E46
  1. The Spec E46 class is a class that uses a non-M e46 chassis with a specific level of preparation emphasizing driver skills and execution versus car preparation.
  1. Vehicle safety equipment must meet or exceed BMW CCA Club Racing published safety requirements, as listed in section III. Safety.
  2. Specific rules for car preparation, required parts, and equipment is available at <http://spece46.com>.
  3. Competitors must have a copy of the Spec E46 (electronic versions acceptable) available.

#### 4. Power to Weight Classes

1. The BMW CCA Club Racing PWR (Power to Weight Ratio) class is designed to be open to many different BMW race cars with minimal restrictions and ease of complying with the class rules. Cars will be classed primarily based on Horsepower to Weight Ratio. The PWR Class will earn BMW CCA Club Racing points and be eligible for annual awards.
2. Vehicle safety equipment must meet or exceed BMW CCA Club Racing published safety requirements, as listed in section III. Safety.
3. **WARNING:** The PWR Class is intended to allow a wide range of existing BMW race cars to race competitively regardless of initial build target class for the car. The PWR class will be subject to on-going rules modifications, especially in the early phases, in order to facilitate a fair and level playing field.
4. Specific rules for car preparation, required parts, and equipment and FAQ are available at <https://bmwccaclubracing.com/pwr/>

## APPENDIX A: ROLL CAGE SPECIFICATIONS

### A. General

1. The basic purpose of the roll cage is to protect the occupant in case of a rollover or a collision. It must be able to withstand the weight of the car landing on the roof. FIA-approved roll cages (not bolt-in) with a manufacturer's certificate of approval are allowed with any required braces being added. Factory/BMW Motorsport roll cages with documentation (matching serial number to manufacturer's certificate) are allowed.
2. Vehicles issued logbooks before July 1, 2006, may have construction based on the final set of 2005 BMW CCA Club Racing Rules. These vehicles are "grandfathered" and may continue participation in BMW CCA Club Racing. However, their owners or future owners are highly encouraged to update the cages to the current standards.

### 3. Bends

None of the tubing may show any signs of wrinkling, crimping, wall failure, or significant reduction in cross-sectional area. The center radius of the bends may not be less than three times the outside diameter of the roll cage tubing.

### 4. Main Hoop

The main roll cage hoop must be as wide as the full width of the interior and must be as close to the roof as possible without violating the provisions of section Q. Inspection outlined below. One continuous length of roll bar tubing shall be used as the main hoop. The main hoop must consist of not more than four bends maximum, totaling 180 degrees +/- 10 degrees and in the same plane.

### 5. Diagonal Brace

At least one diagonal brace must be used in the same plane as the main hoop. One end of the diagonal brace must attach to the corner, or horizontal part, of the main hoop above the driver's head, within 12 inches of the driver's-side corner. The other end of the diagonal brace must attach to the mounting plate (or to the main hoop as close to the mounting plate as practically possible) diagonally opposed to the driver's head (passenger floor).

### 6. Hoops

#### 1. Option 1 – Forward Hoops

- a. The forward hoops must extend from the main hoop (in a forward direction) to the floor by following the roof and the "A" pillar of the car.
- b. There must be a bar connecting the two forward hoops at the top of the windshield mounted as close to the roof as possible without violating the provisions of section Q. Inspection outlined below. The forward hoops must incorporate no more than four bends each. Optionally, a Halo Hoop (Option 2) or Front Hoop (Option 3) construction is also acceptable.

#### 2. Option 2 – Halo Hoop

A halo bar extends from the main hoop (in a forward direction) following the roof line to the windshield then following along the top of the windshield, then following the roof line back to the main hoop, thus creating a halo over the driver's head. A halo bar must be constructed of one continuous piece of tubing. One down tube following the A pillar must support the halo on each side of the car. The down tubes must incorporate no more than two bends each.

#### 3. Option 3 – Front Hoop

A front hoop is a bar that extends up from the floor, then follows the A pillar up to the roof, then follows the roof line across the top of the windshield, then back down the other A pillar, and then terminates on the floor. There must be one horizontal bar (following the roof line) connecting the

main hoop and the forward hoop on each side of the car. The front hoop must incorporate no more than four bends.

#### 4. Rear Braces

The main hoop must have at least two braces extending to the rear. The braces must be attached as near as possible to the top of the main hoop, and no more than 6 inches below the top. The braces must not contain any bends. There must be at least 30 degrees between the plane of the main hoop and the plane of the rear braces. The main hoop rear braces must be installed to form no more than a 105-degree angle or no less than a 75-degree angle with the main hoop when viewed from the top. They may go through any rear bulkheads provided the bulkhead is sealed around the cage braces.

#### 5. Door Bars/Side Impact Protection

1. At least one roll cage door bar on the driver side and one on the passenger side must be installed.
2. Stock and Prepared classes
  - a. If the roll cage is equipped with side protection door bars that extend to the outer skin of the door, the door's stock side impact beam may be removed.
  - b. If the roll cage door bars do not extend fully to the outer skin of the door, the stock side impact beam, if originally equipped, must not be removed.

#### 3. Foot Protection

A maximum of two additional bars may be extended from each front hoop down bar to the front foot well (two on each side) to protect the occupant's feet/legs. The two foot protection bars on each side must use the same mounting point on the wheel well in Stock and Prepared classes.

#### 4. Mounting Points

The roll cage must be mounted to the floor of the car in six, seven, or eight points. The cage must not go through the firewall in Stock or Prepared classes. The seventh and eighth points must attach to the firewall or front foot wells solely for the purpose of foot protection. All cage attachment points must be mounted to plates. Each required cage bar must terminate on a plate with a 360-degree weld to the mounting plate. There must be only one mounting point per plate. This point is where the required tube mounts. All additional tubes mounted to that plate must be mounted as close to the required tube as possible.

#### 5. Mounting Plates

Each mounting plate must be no greater than 100 square inches and no greater than 12 inches or less than 2 inches on a side. Welded mounting plates must be at least 0.080-inch thick and must contain an inspection hole of .325-inch diameter. Plates may extend onto vertical sections of the structure. Any mounting plate may be multi-angled and must not exceed 100 square inches total including vertical sections. Each mounting plate must have an area of not less than 9 square inches. Each mounting plate must be welded around a minimum of 50 percent of each edge, and with a minimum stitch weld length of 1.5 inches.

#### 6. Tube/Mounting Plate Specifications

Any number of tubes may attach to a plate as long as they are touching each other at the plate. There may be a small gap between tubes to allow welding 360 degrees around each tube. If there is no gap between the tubes, they must be welded around the base as much as possible to form a single figure-8 weld, and the tubes must be welded to each other 2 inches up from the base plate.

#### 7. Welds

All welding must be of the highest quality with full penetration and must conform to the American Welding Society D1.1, 1994 Edition, Structural Welding Code, Chapter 10, Tubular Structures and Standards for the material used. Arc welding should be used whenever possible. It is strongly

recommended that the welder inspect all welds using Magnaflux™, x-ray, or other effective methods. All tubes must be welded 360 degrees around the circumference of the tube.

## 8. Tube Structure Design/Body

Tubes may touch the body in any place (not to violate the provisions of section Q. Inspection outlined below), but must not be attached anywhere except as permitted by the preparation rules. No deformation of the interior body panels is permitted, except that the horizontal part of the sheet metal between the top of the B pillar and the top of the A pillar (next to the driver's and/or passenger's head) may be pushed in to accommodate the roll cage. The intent of this allowed deformation is strictly to allow for more headroom for the driver.

## 9. Additional Reinforcement

Any number of additional reinforcing bars and braces are permitted within the structure of the cage provided they meet all the installation, weld quality, and material, and bend specifications. Installation of additional reinforcing bars or braces does not allow for removal of any required bar, brace, or hoop and does not allow for alterations in these.

## 10. Roll Cage Tubing Specifications

### 1. Material

Seamless or DOM (Drawn over Mandrel) mild steel tubing (SAE 1010, 1020 or 1025) or equivalent, or chromoly steel tubing (SAE 4130) must be used for all roll cage structures. Docol R8 tubing is allowed as long as it maintains the same OD as defined for the weight of the car, meets the SAE 4130 specification, and all other cage build specifications.

### 2. Size

- a. For the purposes of determining roll bar tubing sizes, vehicle weight is as raced, without fuel and driver.
- b. There is an allowance of minus 0.010 inches on all tubing thicknesses. Minimum tubing size for the required tubes of the roll cage is as follows based on weight:

- i. Up to 1,500 pounds

- 1.375" x 0.095" DOM/Chromoly/Seamless

- ii. 1,501 to 2,500 pounds

- 1) 1.500" x 0.095" DOM/Chromoly/Seamless
    - 2) 1.500" x 0.120" ERW\* (No issuance of logbooks for cars with ERW cages after 07/01/03)

\*Specifications listed for reference for inspection of grandfathered vehicles.

- iii. 2,501 to 3,000 pounds

- 1) 1.500" x 0.120" DOM/Chromoly/Seamless
    - 2) 1.750" x 0.095" DOM/Chromoly/Seamless
    - 3) 1.750" x 0.120" ERW\* (No issuance of logbooks for cars with ERW cages after 07/01/03)

\*Specifications listed for reference for inspection of grandfathered vehicles.

- iv. 3001 to 4,000 pounds

- 1) 1.750" x .120" DOM/Chromoly/Seamless.
    - 2) No ERW allowed.

- v. Over 4,000 pounds

BMW CCA Club Racing Rules 2026 – 1/30/2026

1) 2.000" x 0.120" DOM/Chromoly/Seamless.

2) No ERW allowed.

### 3. Bending Allowances

If the maximum number of bends is exceeded, all components must be made from the tubing size listed for the next heavier category and must be approved by a BMW CCA Club Racing Technical Steward.

### 4. Inspections

A 0.1875-0.2500 (3/16-1/4 inch) inspection hole must be drilled in each of the required bars in a non-critical area for the purpose of determining wall thickness. All welds, except those mounted to plates on the floor, must be accessible for inspection (360 degrees).

### 5. Alternate Design/Construction

1. Alternative roll cage design and/or construction may be accepted with the designer's and/or constructor's or structural engineer's certification that the cage meets or exceeds the specifications described herein.
  - a. The certificate must include the certifier's name, address, business name, business license number, and professional credentials.
  - b. The certification document must be attached to the vehicle logbook.
2. If plinth boxes are used, the constructor must include in the certification that the structure includes a load distributing bottom plate.
3. Approval by the National Technical Steward or his/her designee is required.
  - a. Plans/drawings may be submitted in advance.
  - b. Final approval requires a physical inspection.

### 4. Diagram – Typical Roll Cage Diagram

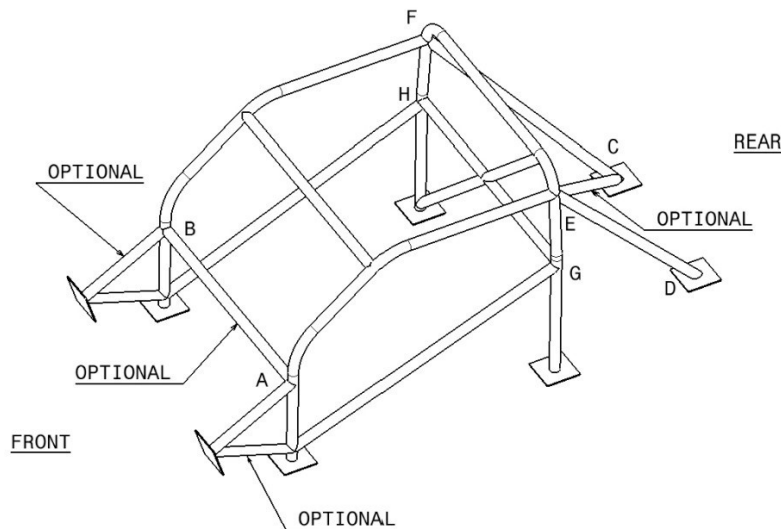

## APPENDIX B: HARNESS BELT SUPPLEMENTAL INFORMATION

### A. Approved Belt Configurations

All harness belts must be installed based on the instructions provided by the harness belt manufacturer. Figure 1 details the recommended installation angles of each harness belt anchor point based on the latest testing completed by the FIA.

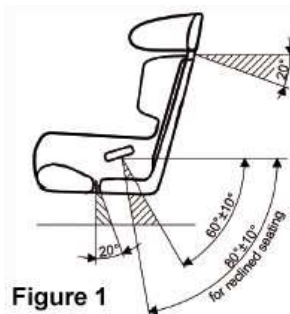

#### 1. Standard Belt

Six-point system for automobiles with an upright (to 30 degrees) seating position. (See Figures 2-4.)

- a. A six-point system consists of a 2-inch or 3-inch lap belt, 3-inch shoulder straps (2-inch allowed with HANS), or 2-inch shoulder straps with 3-inch wide professional padding (padding **not** allowed with HANS), and two approximately 2-inch leg straps. The buckles for the lap and shoulder straps must be of metal-to-metal, quick-release type at the locking mechanism (such as cam-lock).

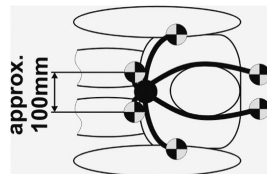

Figure 2

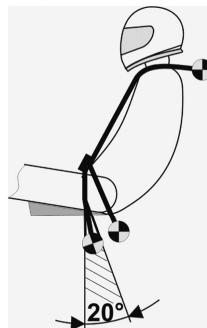
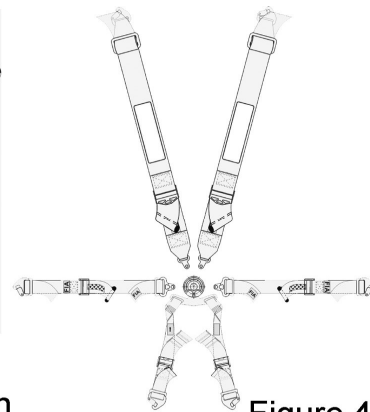

Figure 3



#### Standard 6-Point Belt Installation

- b. The dual leg straps have a single metal-to-metal connection to the locking mechanism and a separate mounting point to the floor or roll cage for each leg of the anti-submarine strap. Leg straps must pass through the sub-strap hole provided in the race seat located immediately in front of the crotch. Locate the mounting points by following the plane of the shoulder belts as they pass over the chest extending the plane to intersect the floor and then measure a 20-degree angle rearward. This is the center point. Measure 2 inches left and right of the center to locate each mounting point for an eyebolt or direct bolt. If the legs are wrapped, the center point is the center of the webbing for each strap. A seventh point is not used in this configuration.

## 2. Formula Belt

Six or seven point system for automobiles with semi-reclined (recline of +30 degrees) seating position. (See Figures 5-7.)

- a. Consists of a 2-inch or 3-inch lap belt, 3-inch shoulder straps (2-inch allowed with HANS), or 2-inch shoulder straps with 3-inch wide professional padding (padding **not** allowed with HANS), and two, approximately 2-inch, leg straps. The buckles for the lap and shoulder straps must be of metal-to-metal, quick-release type at the locking mechanism (such as cam-lock or latch-link). Formula style belts with rear mounted sub straps (Figure 5) are not recommended for use in upright seating positions unless a seventh point is added (Figure 5.A).

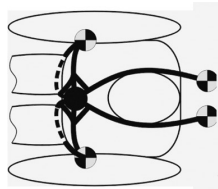

Figure 5

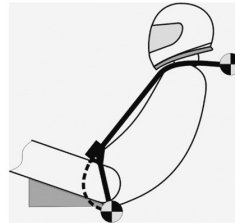

Figure 6

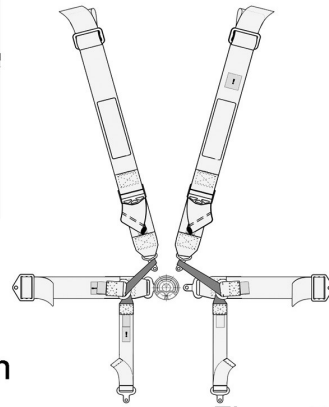

Figure 7

### Formula Style Belt Installation

- b. Each side lap belt and leg strap shares a single (or immediately adjacent) mounting point located within the seat or seating tub or at a point with direct unencumbered routing. Each leg strap loops around the shoulder belt connector, passes down through a D-Ring on the lap belt, wraps around the thigh, and passes directly under the driver's bottom outwards to the same or an immediately adjacent location of the lap belt mounting point. The significant incline of the seat bottom combined with the weight of the driver sitting directly on the leg straps helps to load the lap belt thereby reducing ride-up of the lap belt when loaded. If used in an automobile with an upright seating position, a seventh point is recommended and pictured in Figures 5.A-7.A. The purpose of the seventh point is to provide better and faster loading to the lap belt and to help minimize upward movement in the seat allowed by rearward mounted leg straps. Locate the mounting point by following the plane of the shoulder belts as they pass over the chest extending the plane to intersect the floor, and this is the mounting point.

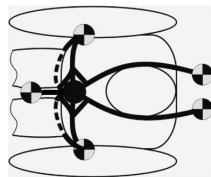

Figure 5.A

Applies only to  
Formula and Hybrid  
Style Belts with rear  
mounted anti-sub straps

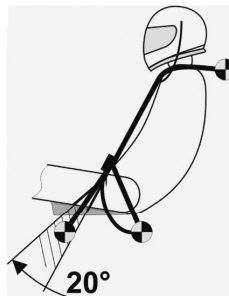

Figure 6.A

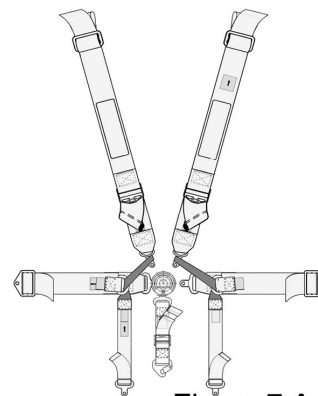
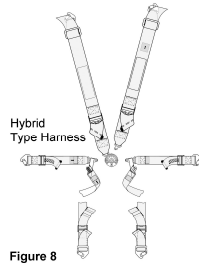

Figure 7.A

### Seven Point Belt Installation

### 3. Hybrid Belt

Six- or seven-point system for automobiles with an upright OR semi-reclined seating position. See Figure 8 for belt layout.



- a. Figures 2 and 3 show upright/forward mounting. Figures 5 and 6 show reclined/rearward mounting. Consists of a 2-inch or 3-inch lap belt, three-inch shoulder straps (2-inch allowed with HANS), and two, approximately 2-inch leg straps.
- b. In this configuration, the leg straps are looped around the lap belt connectors on either side of the locking mechanism. Anti-submarine straps can be mounted in either the Standard Belt mounting configuration or in the Formula Belt mounting configuration. If the Formula Belt mounting configuration is used, a seventh point can be added (see Figure 5.A and 6.A). Forward mounting position is recommended for upright seating positions.

### 4. Lap Belt Mounting

1. The lap belts must be mounted rearward of the pelvis, between two lines drawn at 60 degrees and 80 degrees, below the horizontal (see Figure 1).
2. The lap belts must pass through the seat, without interference, to the attachment points, pulling in plane with the mounting hardware without any visible twisting or edge loading on adjusters or mounting brackets. Mounting points must be as close to the side of the seat and must not rub on any seat brackets, rough, or sharp edges.
3. Lap belt mounting points must be integrated with the frame of the car or to specific welded mounting tabs on the roll cage. If mounting points are located on seat brackets, they must be certified by the bracket manufacturers specifically for such use. Mounting points created in the floor or transmission tunnel must be reinforced with backing plates of sufficient size to spread the load.
4. Lap belts with bolt on connections must allow bracket to pivot either by use of a machined sleeve or by backing the lock nut off just enough so that bracket can pivot. This is critical to prevent loading of one edge. Eye bolts must be aligned properly so that the snap-on connector is not twisted or loaded at an angle that might load one edge of the webbing while the harness is being used.
5. If bolt-in or snap-on mounts are used in conjunction with a three-bar adjuster, the complete wrap must be completed as detailed in Figure 9 and described in section F. Three-Bar Adjusters below.

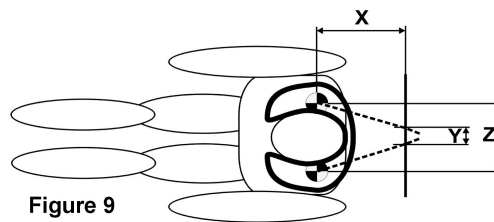

## 6. Shoulder Strap Mounting

1. The shoulder harness must be the over-the-shoulder type. There must be a single release common to the lap belt and anti-submarine straps. Only separate shoulder straps are permitted. Y-type shoulder straps are not allowed. H-type configuration is allowed.
2. The shoulder harness shall be mounted as closely behind the seat back as possible, not to exceed 12 inches.
3. The shoulder harness must be mounted at an angle of 0 degrees to 20 degrees from the horizontal plane measured from the top of the shoulder or the top of the HANS (see Figure 1). In no case shall the shoulder harness be mounted above the horizontal at shoulder height.
4. The shoulder straps must pass over the driver's shoulders (or over the HANS), through the seat, in a direct line to the attachment points without any interference caused by the seat back openings or other obstacles. The formula  $Y = Z - (X * .50)$  can be used to determine the ideal distance between attachment points (see Figure 9). Where the shoulder belts are wrapped around a harness bar, the Y dimension is measured from the centerline of the webbing of each shoulder strap. Where the shoulder belts are bolted, the Y dimension is measured center to center of each mounting bolt.
5. Proper alignment of shoulder straps, unencumbered belt routing, seat opening clearances, and optimum attachment locations will be inspected and verified with the driver seated in the car and wearing an approved head and neck restraint system, the harness belts, and a helmet.
6. In cases where the driver is in a semi-reclining position, the shoulder harness must be attached so that the angle between a line drawn through the driver's spine and the shoulder harness is 70 degrees or greater.
7. Sternum straps are not recommended and are not permitted with a HANS device.

## 8. Anti-Submarine Leg Strap Mounting

1. The double leg straps of the six-point system may be attached to the floor, to a purpose-built element of the cage, or to purpose-built mounting points in the seat as provided by an approved seat manufacturer.
2. A separate attachment point connection must be provided for each leg strap.
3. Attachment points may use bolts, eye bolts with snap-on connectors, or wrap mounts to roll cage, seat, or chassis points designed for the sub- strap loads.
4. Bolts and eye bolts through the floor must be reinforced with backing plates provided by the harness manufacturer or large washers on the underside to spread loads.
5. Wrap mounts to specific bars as part of the cage are allowed using only wrap mount hardware provided by the harness manufacturer following the manufacturers defined wrapping instructions.
6. Formula belt and Hybrid belt anti-sub leg straps may share the lap belt mounting point in rearward mounting installations provided there is a direct unencumbered routing as outlined in the belt descriptions. A seventh point is always recommended when sub-straps are mounted rearward to points at or near the lap belt.

## 7. Webbing Material

The material of all straps must be nylon or Dacron polyester, and in new or perfect condition. Belts showing any significant signs of wear will be disallowed at the discretion of the Technical Steward, regardless of expiration date.

## 8. Three-Bar Adjusters

Three-bar adjusters may be used for wrap mounting shoulder belts around harness bars or leg straps around mounting bars. The adjusters can also be used to secure webbing wrapped through attachment hardware. When three-bar adjusters are used, they must be placed as close to the mounting points as possible. Figures 10 through 14 have the proper wrapping techniques detailed in them:

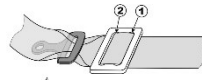

Figure 10

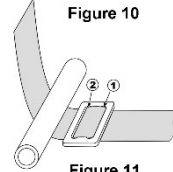

Figure 11

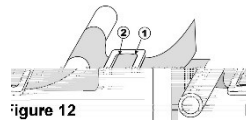

Figure 12

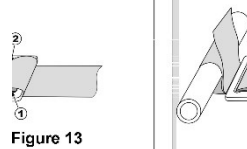

Figure 13

1. Slide the webbing through slots 1 and 2 as shown in Figure 10.
  2. Make sure the protruding strap end is long enough to have sufficient webbing length available for the following wrapping procedure. A minimum of 360 to 400 mm (14.2 to 15.75 inches) is recommended.
  3. The three-bar slide must be positioned as close as possible to either the roll cage bar or to the end bracket.
  4. Wrap the free strap end from underneath around the roll cage bar or through the webbing slot of an end bracket.
  5. In case of the combination of a 50 mm bracket slot and 75 mm webbing, fold the webbing in as shown in Figure 13.
  6. Wrap webbing back through slot 2 and 1.
  7. Fold strap end back and run it through slot 2 again.
  8. Make sure the strap end protrudes at least 100 mm (4 inches) or even longer from slot 2. If it is less than 100 mm, disassemble and start over again. If longer, roll in the strap end and fix it by a cable tie to the shoulder belt.
  9. Check again for proper shoulder belt tilt lock adjuster positioning and for the three-bar slide to be as close as possible to the roll cage bar or end bracket.
- ### 10. Mounting Points and Hardware
1. The minimum acceptable bolts used at the attachment points of lap, shoulder, or anti-submarine straps must be an SAE Grade 5 minimum diameter of 0.325 inches.
  2. Where possible, the lap belt, shoulder harness, and anti-submarine straps should be mounted to the roll structure, or frame of the car. Where this is not possible, harness manufacturer-provided

or equivalent backing plates, or large diameter mounting washers or equivalent must be used to spread the load. Bolting through aluminum floor panels, etc., is not acceptable.

3. Straps using a hook with a spring-loaded clip, which attaches to an eyebolt, must use a cotter pin or safety wire through the small hole to prevent the clip from opening.

## APPENDIX C: ELECTRICAL DISCONNECT SPECIFICATIONS

1. A standard electrical disconnect (battery cut-off) switch is required on all cars competing in the BMW CCA Club Racing program.
2. This switch must be wired such that electrical power to all circuits including the alternator is disconnected, except to an electrically operated on-board fire extinguishing system. The engine must stop running when the switch is activated.
3. In the interest of convenience, the switch may be mounted in the compartment near the battery and operation effected by a pull wire passing to the outside. The preferred location of the pull wire is on the driver's side. It must be clearly visible and its position marked with an approved decal of lightning bolt and the word "OFF".



4. The decal can be placed on the window glass as opposed to the bodywork, as close as possible to the pull wire. It is recommended that the pull wire be painted red for visibility. Those vehicles with a permanently mounted switch or pull wire in another location will be allowed that alternate location provided the position is clearly marked with the approved decal and the switch or pull wire is easily accessible from outside the vehicle.
5. This requirement can easily be accomplished with the fabrication of a simple bracket to hold the switch near the battery. Braided wire can be used for the pull and it should pass through a small bracket mounted inside the compartment. A loop in the end of the cable completes the installation. Pulling the cable rotates the switch and disconnects the battery from the circuit.

## APPENDIX D: VEHICLE CLASSIFICATION AND SPECIFICATIONS

### A. Sport and Prepared

1. Vehicles of the same engineering designation (for example, E36, E46), type (for example, 325, 330, 318), configuration (for example, two-door, four-door, all-wheel drive) and horsepower will be weight equalized to the lowest of the model year factory weights.
2. Cars will be initially classified based upon published factory stock weight (pounds) and published factory stock power (SAE bhp) using lbs/bhp ratios as follows:

<b>Classification</b>	<b>Lbs/bhp Ratio</b>
G	Under 10.00
H	12.50 – 10.00
I	12.50 – 13.99
J	14.00 – 16.59
K	16.60 – 18.99
L	19.00 – 22.49
M	22.50 and over

### 3. Modified

Cars will be classified based upon actual engine displacement as follows:

<b>Classification</b>	<b>Engine Displacement (cc)</b>
A	Over 5000.00
B	3499.001 – 5000.000
C	2980.001 – 3499.000
D	2199.001 – 2980.000
E	1800.001 – 2199.000
F	Under 1800.000

#### 4. Official Vehicle Specifications

..	Model	Product Years		Fact BHP	Fact Wt.	Stock Wt.	Lbs./bhp	Class	PREP Wt.
Type 114	1602	1971	1975	85	2161	2161	25.42	M	2075
Type 114	2002	1968	1973	106	2210	2210	20.85	L	2122
Type 114	1600-2	1966	1971	85	2072	2072	24.38	M	1989
Type 114	1600TI	1967	1968	105	2116	2116	20.15	L	2031
Type 118	1500 4-dr	1962	1964	90	2370	2370	26.33	M	2275
Type 118	1600 4-dr	1964	1966	83	2359	2359	28.42	M	2265
Type 118	1800 4-dr	1963	1971	90	2403	2403	26.70	M	2307
Type 118	1800TI 4-dr	1964	1966	124	2400	2400	19.35	L	2304
Type 121	2000cs	1965	1970	121	2646	2646	21.87	L	2540
Type 121	2000TI 4-dr	1966	1970	135	2535	2535	18.78	K	2434
Type 121	2000tii	1969	1972	130	2579	2310	17.77	K	2218
E3	2500	1968	1976	170	3005	3005	17.68	K	2885
E3	2800	1968	1971	170	2998	2998	17.64	K	2878
E3	3.0s	1973	1976	170	3320	3320	19.53	L	3187
E3	3.0si	1975	1976	176	3420	3420	19.43	L	3283
E3	Bav.Euro 2.8	1976	1976	170	3420	3420	20.12	L	3283
E3	Bavaria	1971	1972	170	2954	2954	17.38	K	2836
E3	Bavaria	1973	1974	180	3235	3235	17.97	K	3106
E6	2002	1974	1976	106	2370	2210	20.85	L	2122
E6	2002tii	1971	1973	130	2310	2310	17.77	K	2218
E6	2002tii	1974	1974	125	2420	2310	18.48	K	2218
E9	2800cs	1968	1971	170	3025	3025	17.79	K	2904
E9	3.0cs	1971	1975	180	3175	3175	17.64	K	3048
E9	3.0CSi	1971	1975	176	3086	3086	17.53	K	2963
E9	3.0CSL	1973	1975	206	2800	2800	13.59	I	2688
E21	320i	1977	1979	110	2601	2601	23.65	M	2497
E21	320i	1980	1983	101	2396	2396	23.72	M	2300
E24	633CSi	1978	1982	177	3500	3280	18.53	K	3149
E24	633CSi	1983	1984	181	3280	3280	18.12	K	3149
E24	635CSi	1985	1986	182	3375	3375	18.54	K	3240
E24	635CSi	1988	1989	208	3550	3550	17.07	K	3408
E24	635CSi Euro	1978	1984	218	3153	3153	14.46	J	3027
E24	M6	1987	1989	256	3570	3570	13.95	I	3427
E24	M6 Euro	1983	1989	286	3308	3308	11.57	H	3176
E28	528e	1982	1988	121	3100	3100	25.62	M	2976
E28	533i	1982	1984	181	3120	3120	17.24	K	2995
E28	535i	1985	1988	182	3270	3270	17.97	K	3139

..	Model	Product Years		Fact BHP	Fact Wt.	Stock Wt.	Lbs./bhp	Class	PREP Wt.
E28	535is	1987	1988	182	3270	3270	17.97	K	3139
E28	M5	1987	1988	256	3420	3420	13.36	I	3283
E28	M5 Euro	1987	1988	286	3155	3155	11.03	H	3029
E28	M535i Euro	1986	1986	218	3058	3058	14.03	J	2936
E30	316 Euro	1984	1990	90	2183	2183	24.26	M	2096
E30	318i	1984	1985	102	2361	2361	23.15	M	2267
E30	318i 4-dr	1990	1991	134	2657	2602	19.42	L	2498
E30	318is	1990	1991	134	2602	2602	19.42	L	2498
E30	325/325e	1984	1985	121	2770	2770	22.89	M	2659
E30	325/325e	1986	1986	121	2770	2770	22.89	M	2659
E30	325es	1986	1988	121	2785	2785	23.02	M	2674
E30	325	1987	1988	121	2765	2765	22.85	M	2654
E30	325i	1987	1988	168	2850	2811	16.73	K	2699
E30	325i	1989	1989	168	2895	2811	16.73	K	2699
E30	325i	1990	1991	168	2811	2811	16.73	K	2699
E30	325is	1987	1988	168	2815	2811	16.73	K	2699
E30	325is	1989	1991	168	2865	2811	16.73	K	2699
E30	325iX	1988	1990	168	3010	2955	17.59	K	2837
E30	325iX	1991	1991	168	2955	2955	17.59	K	2837
E30	M3	1988	1991	192	2733	2733	14.23	J	2624
E31	850CSi	1994	1994	372	4240	4240	11.40	H	4070
E34	525i	1989	1990	168	3395	3395	20.21	L	3259
E34	525i	1991	1992	189	3484	3484	18.43	K	3345
E34	525i	1993	1995	189	3484	3484	18.43	K	3345
E34	530i	1993	1995	215	3627	3627	16.87	K	3482
E34	535i	1989	1993	208	3570	3570	17.16	K	3427
E34	540i	1995	1995	282	3693	3693	13.10	I	3545
E34	M5	1991	1993	310	3805	3805	12.27	H	3653
E36	318i 4-dr	1992	1994	138	2867	2867	20.78	L	2752
E36	318i 4-dr	1995	1995	138	2933	2867	20.78	L	2752
E36	318i 4-dr	1996	1997	138	2976	2867	20.78	L	2752
E36	318is	1992	1994	138	2867	2867	20.78	L	2752
E36	318is	1995	1995	138	2933	2867	20.78	L	2752
E36	318is	1996	1997	138	2976	2867	20.78	L	2752
E36	323is	1998	1998	168	3075	3075	18.30	K	2952
E36	325i 4-dr	1992	1992	189	3087	3021	15.98	J	2900
E36	325i 4-dr	1993	1995	189	3087	3021	15.98	J	2900
E36	325is	1992	1992	189	3021	3021	15.98	J	2900
E36	325is	1993	1995	189	3087	3021	15.98	J	2900

..	Model	Product Years		Fact BHP	Fact Wt.	Stock Wt.	Lbs./bhp	Class	PREP Wt.
E36	328i 4-dr	1996	1998	190	3120	3120	16.42	J	2995
E36	328is	1996	1998	190	3120	3120	16.42	J	2995
E36	M3	1995	1995	240	3175	3175	13.23	I	2970
E36	M3	1996	1999	240	3175	3175	13.23	I	2970
E36	M3 4-dr	1996	1998	240	3175	3175	13.23	I	2970
E36	M3 Light Wt (Stock)	1995	1995	240	2950	2950	12.29	H	n/a
E36	M3 Light Wt (Prepared)	1995	1995	240	2950	n/a	n/a	I	2970
E36	M3 w/ Euro S50B30 swap	1995	1999		3175	n/a	n/a	H	2900
E36	M3 w/ Euro S50B32 swap	1995	1999		3175	n/a	n/a	H	3200
E36/5	318ti	1995	1995	138	2745	2745	19.89	L	2635
E36/5	318ti	1996	1999	138	2745	2745	19.89	L	2635
E36/5	318ti Active	1996	1999	138	2745	2745	19.89	L	2635
E36/7	Z3 1.9	1997	1998	138	2701	2701	19.57	L	2593
E36/7	Z3 2.3	1999	2000	170	2899	2899	17.05	K	2783
E36/7	Z3 2.5i	2001	2002	184	2899	2899	15.76	J	2783
E36/7	Z3 2.8	1997	1998	189	2844	2844	15.05	J	2730
E36/7	Z3 2.8	1999	2000	193	2910	2844	14.74	J	2730
E36/7	Z3 3.0i	2001	2002	225	2910	2910	12.93	I	2794
E36/7S	M Roadster	1998	2000	240	3086	3086	12.86	I	2963
E36/7S	M Roadster	2001	2001	315	3086	3086	9.80	G	2963
E36/7S	M Roadster	2002	2002	315	3131	3086	9.80	G	2963
E36/8	Z3 Cpe 2.8	1999	2000	193	2943	2943	15.25	J	2825
E36/8	Z3 Cpe 3.0i	2001	2002	225	2943	2943	13.08	I	2825
E36/8S	M Coupe	1998	2000	240	3131	3131	13.05	I	3006
E36/8S	M Coupe	2001	2002	315	3131	3131	9.94	G	3006
E39	525i	2001	2003	184	3450	3450	18.75	K	3312
E39	528i	1997	1998	190	3450	3450	18.16	K	3312
E39	528i	1999	2000	193	3495	3495	18.11	K	3355
E39	530i	2001	2003	225	3494	3494	15.53	J	3354
E39	540i	1997	1998	282	3748	3748	13.29	I	3598
E39	540i Sport/6	1999	2002	282	3748	3748	13.29	I	3598
E39	540i Sport/6	2003	2003	290	3748	3748	12.92	I	3598
E39	M5	2000	2003	394	4024	4024	10.21	H	3863

..	Model	Product Years		Fact BHP	Fact Wt.	Stock Wt.	Lbs./bhp	Class	PREP Wt.
E46	323i	1999	2000	170	3153	3153	17.1	K	2901
E46	325i	2001	2001	184	3241	3197	16.2	K	2982
E46	325i	2002	2003	184	3219	3197	16.1	K	2961
E46	325Ci	2001	2001	184	3252	3197	16.2	K	2982
E46	325Ci	2002	2003	184	3197	3197	16.0	K	2941
E46	325xi	2001	2001	184	3494	3461	17.5	K	3214
E46	325xi	2002	2003	184	3461	3461	17.3	K	3184
E46	328i	1999	2000	193	3197	3197	15.2	J	2941
E46	330i	2001	2001	225	3318	3285	13.6	J	3053
E46	330i	2002	2003	225	3285	3285	13.4	J	3022
E46	330i Perf. Pkg.	2003	2005	235	3285	3430	12.9	J	3022
E46	330Ci	2001	2001	225	3351	3285	13.7	J	3083
E46	330Ci	2002	2003	225	3285	3285	13.4	J	3022
E46	330xi	2001	2001	225	3527	3483	14.4	J	3245
E46	330xi	2002	2003	225	3483	3483	14.2	J	3204
E46	M3	2001	2003	333	3415	3415	9.4	H	3142
E52	Z8	2001	2003	394	3494	3494	8.87	G	3354
E85	Z4 2.5i	2003	2005	184	2932	2932	14.7	J	2697
E85	Z4 3.0	2007	2008	215	3020	3020	12.9	J	2778
E85	Z4 3.0i	2003	2003	225	2998	2998	12.3	I	2758
E85	Z4 3.0si	2007	2008	255	3086	3086	11.1	H	2839
E85	Z4 M Roadster	2006	2011	330	3197	3197	8.9	G	2941
E86	Z4 Coupe	2006	2010	255	3108	3108	11.2	H	2859
E86	Z4 M Coupe	2006	2010	330	3230	3230	9.00	G	2972
E82	128i	2008	2012	230	3252	3252	12.8	J	2951
E82	135i	2008	2012	300	3373	3373	10.3	G	3103
E90/92	325i	2006	2006	215	3285	3285	14.1	J	3022
E90/92	325i Sport	2006	2006	215	3351	3285	14.3	J	3083
E90/92	325Xi	2006	2006	215	3560	3550	15.2	J	3275
E90/92	328i	2007	2008	230	3340	3340	13.4	J	3073
E90/92	328i	2010	2010	230	3351	3351	13.4	J	3083
E90/92	328xi	2007	2008	230	3582	3582	14.3	J	3295
E90/92	330i	2006	2006	255	3417	3415	12.3	I	3144
E90/92	330i Sport	2006	2006	255	3450	3415	12.4	I	3174
E90/92	330Xi	2006	2006	255	3627	3540	13.1	I	3337
E90/92	335i	2007	2012	300	3571	3571	11.0	G	3285
E90/92	335i xDrive	2010	2012	300	3759	3759	11.5	H	3458
E90/92	M3	2008	2013	414	3704	3704	8.2	G	3408
F20	128	2013	2019	230	3252	3252	14.1	J	2992
F22	228	2013	2020	240	3260	3260	13.5	I	2999
F30	320	2012	2015	180	3295	3295	18.3	K	3031
F30 LCI	328	2016	2019	240	3360	3360	14.0	J	2999
F32	428	2014	2020	240	3450	3450	14.4	J	3174
F80	M3	2015	2018	425	3540	3450	8.3	G	3257
F82	M4	2015	2020	425	3530	3530	8.3	G	3248
F87	M2	2016	2021	365	3540	3540	9.5	G	3174

..	Model	Product Years		Fact BHP	Fact Wt.	Stock Wt.	Lbs./bhp	Class	PREP Wt.
R50	Mini Cooper	2002	2006	115	2524	2524	21.95	L	2423
R53	Mini Cooper S	2002	2004	163	2678	2678	16.43	J	2571
R53	Mini Cooper S	2005	2006	168	2678	2678	15.94	J	2571
R53	Mini Cooper S JCW Package	2005	2006	207	2678	2678	12.94	I	2571
R56	MINI Cooper	2006	2008	118	2524	2524	21.39	L	2423
R56	MINI Cooper	2010	2010	118	2568	2568	21.76	L	2465
R56	MINI Cooper S	2006	2008	172	2634	2634	15.31	J	2529
R56	MINI Cooper S	2010	2010	172	2679	2679	15.58	J	2571
R56	MINI Cooper S JCW Package	2007	2010	208	2701	2701	12.99	I	2593

5. Official Spec E36™ Specifications

Spec E36 weights include the driver and all personal safety equipment.

Factory Code	Model	Product Years		Fact BHP	Fact Wt	SE36 Weight	SE36 Lbs/HP
E36	325i 4-dr	1992	1992	189	3087	2760	14.60
E36	325i 4-dr	1993	1995	189	3087	2760	14.60
E36	325is	1992	1992	189	3021	2760	14.60
E36	325is	1993	1995	189	3087	2760	14.60
E36	328i 4-dr	1996	1998	190	3120	2830	14.89
E36	328is	1996	1998	190	3120	2830	14.89

6. Official E30 M3 Touring Car Specifications

1. E30 M3 Touring Car Class weights include the driver and all personal safety equipment.
2. Minimum weight is subject to adjustment for Transition Allowances in M3 Touring Class section 9.v.v.1.

Factory Code	Model	Product Years		Class	E30M3TC Weight
E30	M3	1988	1991	M3	2550

## APPENDIX E: FLAGS, SIGNALS, AND COMMUNICATION

### A. Purpose and Methods

1. Course officials (flaggers) are stationed around the course in various locations to provide communication. They serve two main functions with respect to communications. First, they communicate information to the drivers on course. Second, they provide communication about the status of their assigned area to Race Control. Course officials provide one of the most crucial services available to the drivers while on course.
2. In general, there are many methods used by the officials to effectively communicate with the drivers throughout the day. However, this section addressed the methods of communication that are most commonly used to provide information to the drivers while they are on course and in the pit lane.
3. The use of colored flags, lights, signs, and hand signals are the most common ways of providing information and commands to the drivers. For the purposes of this section, the term "signal" may be used generically, to describe any one of these forms of communication, or any combination thereof.

#### 4. Signal (Flag) Categories

There are five basic categories of signals. Any given signal can fit into any one or more of the following categories:

- a. Global signals provide information about the entire course and/or the status of the session.
- b. Local signals provide information about the conditions that pertain to a particular section of track.
- c. Personal signals provide information that is specifically meant for a particular driver only.
- d. Command signals dictate an order to follow the applicable procedures listed in this section, and immediate compliance is mandated. Certain command signals may also provide some advisory information in addition to issuing a mandatory order. This is a side benefit.
- e. Advisory signals provide useful information or serve as a warning to the driver(s). This information is not a command and is meant simply to inform or advise the driver(s).

#### 5. Flag Descriptions and Meanings

##### 1. Green Flag



- a. Categories: Advisory, Global
- b. Description: Solid green, waving or motionless, and usually only displayed at the starting line, as designated by the markings at the facility.
- c. Uses: Advises drivers that the session has begun. This flag pertains to the condition of the entire course at the time that it is being displayed. Local condition/command flags may be displayed with it. The green flag indicates the course is clear.

##### 2. Checkered Flag

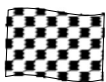

- a. Categories: Command

- b. Description: : A pattern of alternating black and white squares. The pattern resembles a chessboard.
- c. Uses: Functions to inform the drivers that the session is over. This flag is not global because the drivers that have not passed by this flag are driving under green flag conditions. Command: It is a command to drivers are to continue cautiously for the remainder of the lap, and exit the track via pit lane. Passing after the checkered flag may be done if necessary; however, drivers must use caution.

### 3. Yellow Flag – Standing

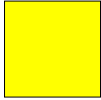

- a. Categories: Command, Advisory, Local
- b. Description: A solid motionless yellow flag, displayed at any flag station found anywhere around the course.
- c. Uses: This is used locally to advise drivers that a hazard is close and may be displayed at one or more of the flag stations just before reaching a waving yellow. As a command, it indicates drivers must slow their vehicles in preparation for any evasive maneuvers that may be necessary to avoid a potential hazard. Absolutely **no passing** is permitted from a point tangential to the first station displaying the yellow flag until completely past the incident(s) and until such a point as the racer can visually confirm that the next staffed flag station is in a green flag (that is, no flag) condition.

**Note:** If this flag is displayed to indicate a hazard on or near the course, it may be rescinded after one or two laps even if the hazard remains; the hazard then becomes part of the course.

### 4. Yellow Flag – Waving

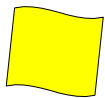

- a. Categories: Command, Advisory, Local
- b. Description: A solid waving yellow flag displayed at a flag station found anywhere around the course.
- c. Uses: This is used locally to advise drivers that there is extreme danger in the immediate area. As a command, it indicates drivers must significantly slow their cars in preparation for any necessary evasive maneuvers or come to a complete stop to avoid striking a potential hazard. **No passing** is permitted from a point tangential to the first station displaying the yellow flag until completely past the incident(s) and until such a point as the racer can visually confirm that the next staffed flag station is in a green flag (that is, no flag) condition.

**Note:** If this flag is displayed to indicate a hazard on or near the course, it may be rescinded after one or two laps even if the hazard remains; the hazard then becomes part of the course.

### 5. Double Yellow Flags (Full Course Yellow)

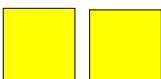

- a. Categories: Command, Global

BMW CCA Club Racing Rules 2026 – 1/30/2026

- b. Description: One or two solid motionless yellow flags, displayed at every staffed flag station around the course.
- c. Uses: **No passing** is permitted. **This is used to indicate a pace car condition.** This means that there might be a problem somewhere on the track. Leaders must slow to pace car speed. Trailing cars need to also slow, but drive at a brisk, safe speed until they have closed with the field. Drivers should be prepared to encounter a local yellow flag situation and/or a pace car (or a slow moving pack behind the pace car). **The displaying of double yellow flags does not guarantee the appearance of a pace car.** It is a command that **no passing** is allowed until either: 1) The pace car has pulled off the course (if applicable) **and** the driver has passed the next staffed flag station that is not displaying any yellow flag(s); or 2) the driver has passed the last staffed flag station (displaying any yellow flags or not) **and** the green flag is displayed at Start/Finish. Cars may carefully pass emergency vehicles. Cars may pass other cars that are disabled or cannot keep the pace as signified by the driver raising an arm out of the window.
- d. Under race conditions:
  - i. The pits are closed when the full course yellow condition is declared.
  - ii. The pits will be reopened to each car once that car has passed the starter displaying the restart green flag.
  - iii. Under the discretion of the event Competition Steward, the pit lane may be opened during full course yellow conditions, described under **IV.D.5.b.v.4.**
  - iv. Cars in the pit lane when a full course yellow condition is declared will be allowed to rejoin at the back of the field sequenced in the order they arrive at reentry.

6. Black Flag – Furled



- a. Categories: Advisory, Personal
- b. Description: Solid black and “furled,” which means “rolled up” and pointed, or shaken, at an intended driver. It may be displayed at any location around the course and is sometimes accompanied by a sign indicating the car number of the intended driver.
- c. Uses: The furled black flag is advisory only. It is displayed to a particular driver as a warning from the officials when a driver has committed a slight infraction or is driving in a dangerous manner. It also means that if the infraction or dangerous driving occurs again, the driver may receive an open black flag.

7. Black Flag – Open



- a. Categories: Command, Personal
- b. Description: Solid black and usually displayed motionless, although sometimes waived in special cases when needed. It is displayed from the starter's stand, and whenever possible is accompanied by a sign indicating the car number of the intended driver.

**Note:** This flag and the corresponding car number sign may also be displayed at another designated station on the course.

- c. Uses: This is used to order (command) a particular driver to enter the pit lane the next time by. The driver must proceed immediately and directly to the black flag station located in pit lane. If there is no black flag station present or specified, the driver will report to the Re-Entry Marshal, located at the head of the pit lane.

The back flag can only be displayed by order of the Competition Steward as relayed through Race Control.

#### 8. Black Flag – All



- a. Categories: Command; Global
- b. Description: A solid black flag will be displayed at all staffed flag stations around the course. A sign with the word "ALL" will accompany the black flag at the starter's stand and may also be shown at another designated station.
- c. Uses: This means that the session has been stopped, drivers should slow their vehicles, and passing is prohibited. This is a command, displayed (globally) to all drivers, ordering them to proceed to the pit lane at a reduced speed. Drivers must be aware that they may encounter hazards somewhere on the course. The local Yellow Flags shall still be in effect where hazards exist. Under race conditions, cars must remain in the pit lane until released to resume competition under full course conditions. Under all other conditions, drivers may return to the paddock or they may choose to remain in the pit lane for further instructions.

The Black Flag can only be displayed by order of the Competition Steward as relayed through Race Control.

#### 9. Red Flag



- a. Categories: Command, Global
- b. Description: A solid red flag will be displayed at all staffed flag stations around the course. (Note: The Red Flag is meant to be used "Standing" (motionless); however, it may be waved at the drivers to indicate urgency.) Additionally, the Red Flag may be displayed at only one flag station.
- c. Uses: This means that the session has been stopped. No passing is allowed, except in an emergency situation to avoid collision. This flag is a command, displayed globally to all drivers, ordering them to come to controlled stop on the side of the track, out of harm's way, and in view of the next staffed flag station. If a driver is forced to stop in an unsafe location due to the position of the vehicle directly ahead of them, the driver may pull off course, pass that vehicle, or take whatever action necessary to protect them from perceived danger. The driver that chooses this option is held accountable for the decision. No penalties should be assessed for actions based solely on the claim of personal safety, as it pertains to this section.

Drivers must remain in their cars and be prepared to restart unless instructed otherwise by an official.

Resumption of a race will use a pace car positioned in front of the overall leader and the course will go to full course yellow for a single file restart after the field has formed behind the pace car.

Resumption of other sessions will be signaled by a change to full course yellow or black flag all.

d. Under Race Conditions:

- i. The pits are closed when the red flag condition is declared.
- ii. The pits will be reopened to each car once that car has passed the starter displaying the restart green flag,
- iii. No work may be performed on any car that was in the pit lane when the black all/ red flag condition was declared. Any work in progress when the black all/ red flag condition was declared must stop, including fueling.
- iv. The race clock and any pit-stop clocks stop when the red flag condition is declared. The race clock and pit-stop clocks restart when the track goes to full course yellow as the field reforms behind the pace car. The clock continues to run under black all conditions.
- v. Cars in the pit lane when a red flag condition is declared will be allowed to rejoin at the back of the field when the course goes to a full course yellow condition sequenced in the order that they arrive at reentry.
- vi. No work may be performed on any car that has stopped on course during the red flag condition, unless done by the course officials or any crewmember with specific permission from the Competition Steward. Cars entering pit lane under black all/ red flag conditions may not start work nor may they exit pit lane to the paddock. Under black all/ red flag conditions, work may resume once the course has gone green.
- vii. The red flag can only be ordered by the Competition Steward. The red flag may be requested by any on-scene emergency response personnel.

10. Passing Flag



- a. Categories: Advisory, Personal
- b. Description: A blue flag with a yellow diagonal stripe, which can be displayed from any staffed flag station around the course. It may be displayed motionless, or in some cases waving.
- c. Uses: This is a personal advisory to alert a particular driver that another vehicle is following very closely or closing rapidly and may attempt a pass. The passing flag may be waved to indicate urgency because another car is closing in from behind at a high rate of speed.

11. Debris Flag/Surface Condition Flag

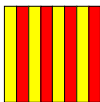

- a. Categories: Advisory, Local
- b. Description: A motionless flag with yellow and red vertical stripes that can be displayed from any staffed flag station around the course.
- c. Uses: This is a local condition advisory that indicates a slippery surface exists (such as oil) or debris may be present on the track surface. Caution is advised.

**Note:** If debris is large, heavy, in the racing line, and/or otherwise presents itself as a hazard that will cause significant damage to a car, a yellow flag may be used along with, or in place of, the debris flag.

## 12. White Flag

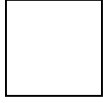

- a. Categories: Advisory, Local, or final lap
- b. Description: A motionless solid white flag that can be displayed from any manned flag station around the course.
- c. Uses: This is a local advisory flag alerting the driver that there is a slow moving vehicle on course. This is usually used to indicate another participant's vehicle is moving slowly. However, it could be used to indicate a safety vehicle on course (presumed to be driving slowly).
- d. A waving white flag at Start/Finish indicates one lap remaining.

## 13. Mechanical Black Flag

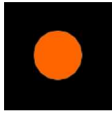

- a. Categories: Command, Advisory, Personal
- b. Description: (also known as the "meatball" flag) A motionless black flag with an orange ball in center. It may be displayed at any location around the course, and is sometimes accompanied by a sign indicating the car number of the intended driver.
- c. Uses: This is a command, displayed to a particular driver, advising them that there is something mechanically wrong with their car, and ordering them to reduce speed and to enter the pit lane at the next opportunity.

## 14. Lights and Meanings

### 1. Pace Car (with lights on)

- a. The pace car may be dispatched in the middle of a session due to any number of causes; however, there is only one common purpose:

The pace car functions to collect the field of cars and slow them to a pace deemed reasonable to Race Control, given the circumstances.
- b. When the pace car is on course, the drivers shall follow it at the same speed.
- c. Those not in sight of the pace car shall close up with the pack at the pace car. They should do this at a subdued race speed, being constantly aware of local flag conditions.
- d. Passing the pace car is not allowed unless motioned to do so from the personnel in the pace car.
- e. The pace car may be different at each event and may even use different lights.
- f. Do not confuse safety vehicles with a pace car. If a driver is unsure of what car/light combination is used for that event, it is his or her responsibility to ask an official.

### 2. Safety Car (with lights on)

- a. At most events, a safety car is used for a wide variety of reasons. It is used to bring extra emergency personnel to a scene when needed. It could be the Medical Director or another official. Regardless of its intended mission, the safety car, when driven on course with its lights on, shall be treated like every other safety vehicle. The driver must expect to be alerted to its presence with the proper flags, and they are free to pass it with care.
  - b. A safety car with its lights off may be treated like any other car.
3. Tow, Safety, and Fire Trucks
- a. When a driver encounters a tow, safety, or fire truck on course, he or she may pass it with due care.
  - b. Emergency response officials usually ride on the back of the trucks and signal the drivers approaching them with instructions. These instructions are three simple hand signals.
    - i. One is a point to the right, which indicates that the driver should pass on the right.
    - ii. Another is a point to the left, which indicates that the driver should pass on the left.
    - iii. The last one is a palm in the air directed straight at the driver. This is a signal to hold back on the pass for the moment.

The officials will signal the driver to pass as soon as possible when it is safe.

If there are no officials on the back, or none of them are signaling the driver, then the driver is free to pass, but with due care.

#### 4. Course Lights

Course lights are not commonly used in road course events; however, there are some places on some tracks, and some night events that do use them. The general rule of thumb is that the color of the light has the same meaning as the corresponding flag. A blinking light is equivalent to a waving flag. A solid light is equivalent to a standing flag.

#### 5. Sign Boards

Signboards are simply another way of communicating to the drivers. Typically, signboards are displayed in the pit lane indicating five minutes, three minutes, and one minute before the start of the session. Each organization has their own set of signs for different reasons.

#### 6. Leading Vehicle Pace/Safety Car

During a full course yellow condition, the driver in the overall lead is expected to slow down and essentially, function as a pace car until such a time as a pace car can properly pick up the lead. To assist the leading driver in determining when he or she is expected to temporarily function as a pace car, the officials will advise, when possible, the drivers and crews who the overall lead car is on FRS channel 7, sub-channel 1.

## APPENDIX F: NORTH AMERICAN POINTS SYSTEM

### A. Introduction

1. The BMW CCA Club Racing Points System is intended to reward driving performance and is therefore scored based on a driver's in-class finishing position rather than overall finishing position.
2. The purpose of the system is to place the emphasis on in-class performance and to widen the scope of the Club Racing program with **friendly** and **safe** competition at BMW CCA Club Racing events and encourages drivers to compete beyond typical geographic boundaries.
3. Safety is, and will always remain, the first priority of Club Racing.
4. Program Structure and Sanctioning
  1. BMW CCA Club Racing is the only authority for awarding BMW CCA Club Racing points and the naming of series champions, both regional and North American. BMW CCA Club Racing retains the authority for naming, titling, and determining any and all sponsors for the BMW CCA Club Racing Series.
  2. All points awarded in the series are awarded to the driver on the basis of technical class of the race car used in competition as defined in the BMW CCA Club Racing rules (for example, D Modified or J Stock). All classes so defined will be eligible for points.
    - a. Points earned in one class may not be transferred to another class.
    - b. Drivers may compete in more than one class.
    - c. Drivers may earn points in more than one race car within a class but may not earn points in more than one race car in a given class in any particular race.
    - d. A Dual Class car's driver may only earn points in one of the two car's classes per event weekend. The driver must choose the class he intends to compete in and designate the class to Timing and Scoring prior to the first on-track session.
  3. Points are only awarded in races sanctioned by BMW CCA Club Racing. Sanctioned races may be run in cooperation with other venues. All sanctioned races will be posted on the schedule on the BMW CCA Club Racing Web site.
  4. Should an increase in the incident rate be attributable to this points system, the system may be altered at any time in any fashion or terminated at any time at the sole discretion of BMW CCA Club Racing. BMW CCA Club Racing assumes no responsibility or liability for any modifications to, or termination of, the BMW CCA Club Racing Points System at any time.
  5. Prizes other than trophies may be awarded as long as all participating, qualified racers have an equal opportunity to win. Contingency sponsors may specifically elect to award prizes based on finishing positions.
6. Type of Events
  1. There are four different types of events that are sanctioned by BMW CCA Club Racing. Each event has a race that is designated as the Feature Race, the results of which are used to determine BMW CCA Club Racing prizes, gifts, or awards. Promoter-provided prizes, gifts, or awards may be awarded at the promoter's discretion regardless of race designation.
    - a. Regular Events

Regular BMW CCA Club Racing events are limited to three points races, where points will be awarded based on the calculations described in the Finishing Position Points section for two races, and at 150 percent for the designated Feature Race. The event organizers will

designate in the registration materials which of the three races will be designated the Feature Race.

b. North American Challenge (NAC) Races

- i. The system provides for one or more special annual events, which are designated as the BMW CCA Club Racing North American Challenge Races. In those events, up to four races may be conducted, three of which will be worth 150 percent position points and one worth 100 percent position points.
- ii. Events receive the designation of the North American Challenge Race solely at the discretion of the Club Racing Chairman.
- iii. The location and date of the BMW CCA Club Racing North American Challenge Races are announced with the initial official release of the season's schedule or as soon as possible thereafter. The location of the North American Challenge Races cannot be duplicated two years in succession, subject to track availability, and will be determined by the Chairman of BMW CCA Club Racing with the advice of the RAC.

c. Premier Events

Premier events are 3 day events where up to four points races are allowed with one race being designated in advance as the Feature Race. The Feature Race and one additional race will be worth 150 percent position points. The two remaining races will be worth 100 percent points. If a race weekend is scheduled for 3 days and is not designated as a National or NAC event, it will default to a Premier event.

d. National Events

At the discretion of the Club Racing Chairman, any event may be designated a National event. Any event receiving the National Event designation will be in addition to the region's allotted Premier event. In National events, up to four points races are allowed, with one race being designated in advance as the Feature Race. The Feature Race will be worth 200 percent position points, two races will be worth 150 percent position points, and the remaining race worth 100 percent position points.

2. Under unusual circumstances, such as bad weather, event organizers in concert with the assigned Competition Steward may redesignate the Feature Race at an event. In such cases, the redesignation must be made prior to the first point's race of the event, and drivers must be informed as soon as possible.

3. Points and Penalty Calculations

1. Points will be awarded to eligible racers as follows:

- a. All points for an event are awarded in the region where the BMW CCA chapter sponsoring the event is located, except for Premier, National, and North American Challenge events. In those cases, the points will be awarded in both the driver's home region and the region where the BMW CCA chapter sponsoring the event is located.
- b. Event Participation Points
  - i. Event participation points may be awarded to each driver who competes in at least one race in an event.
  - ii. The event participation points will be applied to the race in which the racer earns the greatest number of points under Section D.1.c thru D.1.e below.
  - iii. Five event participation points will be awarded to every racer who takes a green flag in any race within a particular event. For endurance races, each non-starting driver who completes at least 25 percent of the race car's laps in an endurance race will also be awarded five event participation points. All non-starting drivers are responsible for confirming their lap participation with the event Timing and Scoring Steward within 20 minutes of the end of the BMW CCA Club Racing Rules 2026 – 1/30/2026

race. Failure to do so will nullify any claim to these event participation points. For this purpose, an endurance race is defined as a race with a minimum announced length of 45 minutes or longer **and** a mandatory pit stop.

- iv. A maximum of five event participation points will be awarded to any one driver in any one class under Section D.2.d below. Drivers who participate in more than one class during the event are eligible for event participation points in each class if they qualify under Section D.2.d below.
  - v. For purposes of calculating a driver's championship points total in a given class, no driver can accumulate more than 25 event participation points.
- c. Finishing Position Points.
- i. Points will also be awarded by finishing position in announced points-eligible races, in each competing class, as follows:
    - 1) 1st = 10
    - 2) 2nd = 7
    - 3) 3rd = 5
    - 4) 4th = 4
    - 5) 5th = 3
    - 6) 6th = 2
    - 7) 7th = 1.
  - ii. For endurance races held at National, Premier, and North American Challenge events, the appropriate multiplier will affect the finishing position points only.
- d. Bonus Points
- i. Each racer that finishes a race will be awarded a bonus of one additional point for each car in class that officially finishes the race behind each points-winning position, up to a maximum of 10 bonus points per race, as follows:
    - 1) One car finishes in class – no bonus points
    - 2) Two cars finish class – the winner gets one point and second none
    - 3) Twenty cars finish in class – the winner gets 10 points and from the 11th place car down, there are no points.
      - ii. The only way the maximum of 10 points is awarded is if 11 cars finish.
      - iii. Did Not Finish (DNF) and Did Not Start (DNS) results do not count for purposes of the bonus points calculation. Bonus points are not eligible for a multiplier for Feature Races or races held at National, Premier, and North American Challenge.
- e. Position Points Multipliers.

Finishing position points for a given race may be multiplied by 150 percent in the following situations:

- i. Feature Races
  - 1) One race at each event will be deemed the Feature Race. The Feature Race may be a sprint or an enduro.
  - 2) Feature Races have finishing position points awarded at 150 percent of the standard values.

- 3) If the Feature Race already have a position points multiplier in effect (as a National, Premier, or North American Challenge event), then no additional points multiplier is added above that level.

- ii. North American Challenge Race

An NAC event awards finishing position points at 150 percent of the standard for up to three races and 100 percent for one additional race.

- iii. Premier Events

- 1) Premier events award finishing position points awarded at 150 percent of the standard values for up to two races.
- 2) Premier events may hold two additional races where finishing position points are awarded at 100 percent of the standard values.

- iv. National Events

National Events award finishing position points awarded at 200 percent of the standard values for a designated Feature Race, 150 percent of the standard values two additional races, and 100 percent for a fourth race.

- v. If these multipliers result in non-integral finishing position points, they are awarded as calculated including half points and are not rounded up.
  - f. If a driver competes in a given class within an endurance race by sharing driving in two or more race cars in that class, he must declare **before** the start of the race which race car will be used for earning points. A driver cannot earn points in a given class in more than one race car in that class in a single race. This declaration must be made in writing to the Timing and Scoring Steward at least one hour before the start of the endurance race. Failure to do so will result in the forfeit of all points earned in that race.
  - g. In the case of a dead heat for any position, the total points involved based on the number tied at the finish shall be divided evenly among those tied.
  - h. BMW CCA Club Racing may, at its sole discretion, and with the concurrence of most of the RAC representatives, award additional finishing position bonus points at a sanctioned event that is the first club race sponsored by any BMW CCA chapter or an event that is held at a track at which there has not been a BMW CCA Club Racing event in two or more years. This designation and the specific level of bonus points to be awarded must be approved prior to the distribution of registration materials for the event. In no case shall such bonus points be more than 100 percent of the normal finishing position points nor apply to more than two races within the event.
  - i. If a racer's race car is reclassified during the season as a result of a mid-season rules change, the points will be carried over with the car to the newly assigned class without penalty. If the race car has mid-season alterations that mandate a class change, no points will be transferred to the new class. If the race car is reclassified as a result of technical violations, all points won in the class in which the car was non-compliant will be forfeited and a point's penalty, under Section D.2.d below, may be applied. Racers of PWR class cars who change classes mid-season (PWR2 to PWR3, etc) will not transfer their points to the new class.

## 2. North American Championship

### 1. North American Champions

- a. Each BMW CCA Club Racing class for which at least one race car in that class was declared a finisher at a minimum of four sanctioned events during the calendar year shall have a North American Champion designated.
- b. The North American Class Champion shall be the racer with the most total points, after any applicable penalties, within a given class subject to the limitation of 12 countable races as per the following Section E.1.c.
- c. Twelve Best Races.
  - i. For the purposes of determining a North American Champion, each driver will have his or her point total calculated using a maximum of 12 races in which he or she has scored points.
  - ii. If the driver has competed in more than 12 races, the 12 races that produced the highest total in any region will be used. If the driver has competed in more than one class, he or she will have separate points totals calculated for each class. Points awarded in a given class cannot be considered in any other class.
  - iii. To be eligible for a North American Class Championship, a racer must have completed a race in a minimum of four events in class during the season.
  - iv. Ties in the final North American Championship points will be resolved based on each driver's grand total of season points. If two or more drivers still remain tied, the driver with the most first place finishes among the 12 races used in determining the points total will be declared as the North American Champion. If two or more drivers remain tied at that point, they will be considered tied for the championship and be designated North American Co-Champions.
  - v. Trophies or plaques will be awarded for the first, second, and third place champions in each class that meets the minimum participation requirements, as long as all the winners have satisfied the minimum participation requirements.

## 2. Regional Challenges

What sets BMW CCA Club Racing apart is the spirit founded in the belief that the fun of the friendly competition is more important than the results and that mutual assistance among racers, when possible, enhances the experience for all. The friendly competitive element can be enhanced by augmenting our National Points Championship with a series of regional focused challenges. Club Racing has expanded the previous Can-Am Challenge with two additional regional Challenges. The challenges are outlined below.

- a. The **Can-Am Challenge**: Paying homage to the historic Can-Am series that spanned the Canadian and United States border from 1966-1974, the Can-Am will include all Club Races at NJMP-Thunderbolt, NJMP-Lightning, CTMP and WGI.
- b. The **Blue Ridge Challenge** will include all Club Races held at VIR, Summit Point, Indianapolis and Mid-Ohio.
- c. The **Southern Challenge** will include all Club Races held at Road Atlanta, Roebing Road and CMP.
  - I. P1 Champions from each Challenge will be determined as follows:
    - For each Challenge, Club Racing will recognize and award trophies to P1 class winners for points earned at the tracks within each relevant Challenge. We will make these calculation race designation agnostic (so straight points – every Challenge series points calculation will be at 100% for all races, no

participation points, no premiums for Premier, NAC, and National event designations)

- Drivers are eligible to compete in all the three Challenges and are eligible for points in each.
- To be eligible for Challenge awards at season end, drivers must complete at least 50% of the races scheduled in the Challenge(s) in which they compete.
- The Canada vs USA element will exist within the CanAm Challenge (using specific driver pairings at each race for Canada v. USA calculations) and will continue to award the CanAm trophy to the winning nation.

## APPENDIX G: DYNO TESTING

Club Racing has multiple classes that utilize a maximum HP or HP to Weight ratio for classing. The following testing procedure will be applied uniformly for all classes.

When cars are being tested on the dyno or in the queue for testing, they are considered to be in impound whether immediately following a competitive on-track session or any other time during the race weekend as determined by Club Racing staff. While the cars are in impound for dyno testing, no mechanical work may be performed on the car other than topping up fluids, torquing wheel bolts or adjusting tire pressures. Once in impound, cars may not return to the paddock for any reason unless directed and supervised by a Tech Steward.

6. The Car must be operated by the Dyno operator or assistant – the racer or his crew are not allowed to operate the car during testing.
7. Tire pressures must be set consistent with on track use (28 to 38 psi, 35 PSI for SE46)
8. Dyno testing must be performed with the engine at normal operating temperature (170F – 225F) Should the coolant temp exceed 230F, the pull should be repeated after the car has cooled down to normal operating temperature. Temperatures may be verified with an external infrared temp gun, a thermocouple based temperature gauge or alternatively an on board temp gauge. Temp is best measured at the thermostat housing.
9. External cooling fans should be employed while the car is on the Dyno.
10. Dyno testing must be performed with the transmission in the gear that is a 1:1 ratio. For most BMW Factory manuals, this is 5th gear (E30s are an exception where it is 4th gear). SMGs and Automatics will need manufacturer's documentation to validate the proper 1:1 gear.
11. The RPM range for testing should start no higher than 2000 RPM and WOT operated until the Rev limiter is engaged.
12. The RPMs should be measured via a spark ignition signal where possible. Calculating RPMs via the wheel speed should be avoided unless there is no alternative.
13. All dyno readings should be corrected to SAEJ1349 Rev JUN901 and the smoothing set to 5.
14. 3 normal runs are required for compliance.
  - a. The HP/Torque graph should be reviewed after each run to ensure the run is normal.
  - b. Additional runs should be completed until 3 normal runs have been logged.
  - c. If after 5 runs there are at least 2 normal runs, the testing is complete.
  - d. The highest reported HP of the 3 normal runs is the official tested HP (or highest of 2 runs when 5 runs have been completed).
  - e. The highest HP should be rounded to the nearest tenth.

## APPENDIX H: RACING GLOSSARY

**Important:** If any of the definitions contained in this glossary appear to be in conflict with a specific rule, the specific rule takes precedence.

**A-P Pillar** – The forward most roof support in a passenger car, which also serves as the side support for the windshield

**Accelerator Pedal** – A foot-operated device that allows the driver to vary the degree of opening of the induction system throttle(s)

**Accessible** – Capable of being reached without removal of other components

**Accumulator** – A pressurized free-piston device, in which the compression of a fixed volume of air by the piston, upon the application of a force caused by fluid under pressure, provides a pressurized reservoir of the fluid

**Active Suspension** – Automatic ride height and/or roll control by an active system receiving power from a pump or compressor

**Adhesive** – A bonding agent designed to cause two or more components to adhere to each other without fusing them into a single component

**Adjustable Timing (Cam) Gear** – A camshaft drive gear or sprocket that permits a range of angular adjustment of the outer portion relative to the attachment point of the driven camshaft.

**Advance Curve** – The degrees of distributor advance from the static setting as a function of rotational speed, usually achieved by a system of rotating weights, springs, and limit stops within the distributor body

**Advance Plate** – The plate inside a distributor on which the ignition points are mounted, which is free to rotate over a prescribed angle in response to the actions of the advance mechanism(s), thus altering the phase relationship of the points and distributor cam

**Advance Springs** – Springs that provide the restoring force against the actions of the advance mechanism(s) in a distributor

**Aerodynamic Device** – An attachment to, or an integral part of, a car intended to generate atmospheric downforce by the action of air flowing through or around the attachment

**Aerodynamic Skirts** – Body panels, movable or fixed, at the bottom of the sides of a car's body, which aid in the creation of "ground effects" downforce by ensuring that little air passing under the car can escape at the sides

**Aeroquip Line** – A brand name, used generically, for a braided metal-covered hose

**Air Cleaner (Filter)** – An induction system component intended to filter particulate matter from the incoming air

**Air Dam** – An aerodynamic piece that attaches to the underside of the bumper or bumper cover, intended to divert some of the air that would normally pass under the car when the car is in motion; for example, E30 chassis cars other than the M3 have a bumper cover and the lower part is an air dam. They are not one piece as in the E30 M3 or E36 chassis cars.

**Air Horn** – See **Velocity Stack**

**Air Pump** – An engine-driven pump intended to provide a supply of air (without fuel) to the engine to assist in the reduction of pollution components

**Air Throttle** – The valve that allows the driver to modulate the volume of air passing into a fuel injection induction system

**Airfoil** – An aerodynamic device or part of a car whereby the flow of air over its surface will generate a vertical force by creating a pressure differential between top and bottom surfaces

BMW CCA Club Racing Rules 2026 – 1/30/2026

**Alter** (verb) – To change a component by modifying it

**Alternator** – A component intended to generate current with which to maintain a proper level of charge in the on-board storage battery

**AN Coupler** – A threaded high pressure hydraulic coupling of the type normally used with metal braided hose

**Annular Discharge** – A carburetor type in which the fuel is introduced into the flowing air from an annulus on the periphery of the main duct

**Anti-Roll Bar** (Sway bar) – A torsion control device connected to a car's structure and to moving portions of the suspension, which is intended to control body roll; some types of anti-roll bars may also serve as a suspension component

**Anti-Submarine Strap** – A safety strap intended to provide additional support against motions of the driver's lower torso in the forward direction

**Aspect Ratio** – The ratio of tire section height to section width, expressed as a percentage

**Attachment Points (Suspension)** – The locations at which the fixed and moving ends of a shock absorber are mounted and/or the location of the suspension component on the frame or structure of a car

**Automatic Transmission** – A transmission that is capable of allowing a car to start from a stop without use of a clutch, which may be shifted from gear to gear without use of a clutch, and in which such shifting of gears is accomplished by hydraulic, pneumatic, or electric actuation

**Automobile** – See **Car**

**Axle Housing** – The housing that contains axle shafts and may provide support for wheel hubs

**Axle Shaft** – A shaft whose purpose is to carry rotational drive from a differential or transaxle to the driven wheels, or simply, to support one or two non-driven wheel hub(s)

**Backing Plate** – A braking component used in drum type brake systems, generally to support the brake shoes and wheel cylinder(s) at a wheel; on a disc brake system this is referred to as a dust shield.

**Baffle** – A plate or panel in a fluid container, which is designed to inhibit the rapid transfer of the fluid within the container when it is subject to changing dynamic forces

**Balance (Verb)** – To minimize the dynamic off-axis forces of rotating components, or to equalize the weights of like reciprocating components

**Balance Pipe** – A tubular induction system component that connects two or more independent branches of the system

**Ball Joint** – A bearing coupling, generally in suspension or steering systems, consisting of two mating surfaces, one convex and one concave, which permits a range of angular displacements of the two attached shafts over a prescribed range

**Ballast** – Non-functional mass fastened inside a car to increase the weight of the car

**Base Circle** – The constant radius portion of a camshaft lobe that is closest to the centerline of the camshaft

**Battery (Storage)** – An on-board electrical storage component that may be used to activate electrical devices or systems, such as starter, ignition, etc.

**Battery Box** – A covered container for an on-board storage battery

**Bearing** – A mechanical component provided to allow connected parts to move with respect to one another in a manner consistent with durability and minimal friction

**Bearing Carrier** – A housing in which the bearings carrying a shaft are mounted.

**Bell Housing** – A nominally bell-shaped extension or attachment to the engine or transmission that serves as a coupler between these assemblies, and usually encloses the clutch/flywheel assembly

**Bezel/Rim** – Outer trim components that determine the assembled appearance

**Bias Ply Construction** – A tire construction in which the structural plies of the main carcass form an angle considerably greater than zero relative to a cross section of the tire

**Big End** – The crankshaft end of a connecting rod

**Blanking Sleeve** – A replacement for a thermostat designed to divert the flow of cooling water away from the cooling system bypass circuit

**Block** – The elemental component of a reciprocating engine that contains at least the cylinder location(s) and the crankshaft mounting points

**Blueprinting** – The practice of engine improvement achieved by the use of selected standard parts and/or by optimizing the factory machined surfaces of stock engine components to achieve the most advantageous specifications within the normal range as defined by the manufacturer for that engine

Within the above definition of blueprinting, any procedures that involve the following are not permitted unless specifically authorized:

The addition of material of any kind to any component (this includes, but is not limited to, the addition of sleeves/bushings and the application of anti-friction, oil shedding and thermal barrier/retention coatings).

The machining, tooling or any other physical or chemical modification (including shot blasting) of any surface that was not originally a factory machined surface. Glass or other media blasting for cleaning purposes only is allowed as long as it does not remove or modify the base material of the original part.

Mixing/matching of parts from any other year, make, model or type of vehicle or engine.

Balancing procedures that involve spot machining of all rotating and/or reciprocating parts (i.e. one rod/piston assembly must remain untouched).

**Note:** Under no circumstances may any factory specification be exceeded as a result of any permitted blueprinting operation(s) (i.e. compression ratio, valve lift, bore, stroke, etc.).

**Body** – All parts of the car licked by the air stream and situated above the belly pan/floor with exception of the roll bar or cage

**Body Panel** – A replaceable section of the body.

**Bodywork** – See **Body**.

**Bolt Pattern** – The arrangement of bolts or other fasteners used to join two components.

**Boost** – The degree of induction pressurizing in a turbo/supercharged engine.

**Boot Cover** – A cover for the area behind the driver/passenger seating area in an open car.

**Bore** – The diameter of a cylinder.

**Boss** – A protrusion from a casting or forging that provides the surface(s) and/or structure necessary to accomplish particular function of the component

**Brake Light** – A signaling light mounted on the rear of the car, which may be actuated only by driver braking actions

**Brake Lining/Pad** – Replaceable friction material that accomplishes braking action by making rubbing contact with the brake drum or rotor

**Brake Rotor** – The disc component of a braking system, which is attached to a wheel hub and provides a friction surface for braking actions

**Braking System** – A system, including hydraulic and mechanical components, which allows the driver to reduce the velocity of a car

**Breather Vent** – An aperture that allows the flow of air into or out of an enclosure

**Bulb** – A lighting system component that contains the actual light emitting element(s).

**Bulkhead** – A partition separating compartments

**Bump Steer** – The change in toe-in or toe-out that results from changes in suspension geometry as the wheel(s) rises or falls from its neutral position

**Bump Stop** – A cushioning pad that acts as the limit to suspension travel in one vertical direction

**Bumper** – A semi-rigid attachment to the structure of a car at the front or rear, which is intended to absorb a portion of low speed front or rear collision forces

**Bushing/Bush** – A sleeve or tubular insert, the purpose of which is to reduce the dimension(s) of an existing hole. A protective liner that cushions noise, friction, or movement such as a rod end or spherical bearing

**C-Pillar** – The body roof support bordering on the rear window or hatch

**Caliper** – A braking system component that is the disc brake equivalent of a wheel cylinder and converts hydraulic pressure into mechanical braking force at a wheel

**Cam Carrier** – That portion of a reciprocating engine that contains the supporting bearings for an overhead camshaft

**Cam Cover** – Equivalent to a valve cover in an engine with an overhead cam

**Camber** – The angle of a wheel relative to true vertical. Negative camber implies that the top of the wheel is closer than the bottom to the car's centerline

**Camber Compensator** – A wheel location device designed to control the wheel camber under varying conditions of bump/rebound

**Camshaft** – An engine component, driven by the crankshaft, the function of which is to actuate the valves, and often, to drive other engine components

**Camshaft Timing** – The phase relationship of the camshaft to the crankshaft, which determines when in the crankshaft cycle the valves will open

**Canard** – A near-horizontal aerodynamic device normally mounted at the extreme front of a (race) car

**Car** – A self-propelled land vehicle running on four wheels, not in a line, which shall be in contact with the ground. At least two wheels shall affect the steering and at least two the propulsion

**Carburetor** – The component of a non-fuel injection induction system that achieves the mixing of fuel and air to create a combustible mixture

**Caster** – The angle that the swivel axis of a steered wheel makes with the vertical in the fore/aft direction

**Catalytic Converter** – An emissions control device in the exhaust system that reduces emissions by catalysis

**Catch Tank** – A container with the purpose of collecting liquid, generally lubricant, vented from an engine, transmission, transaxle, or differential and preventing the loss, from the car, of the liquid.

**cc** – Cubic centimeter (a unit of volume)

**Center-Lock** – A type of road wheel/hub that is retained by a single central fastener

**Centerline** – A line coincident with the axis of rotational symmetry of a component

**Centrifugal Clutch** – A clutch that automatically engages in response to an increase from low engine speed and disengages upon return to low speed operation

**Chain Drive** – A drive system in which the engine power is transmitted through a chain and sprockets

**Check Valve** – A valve designed to prevent the flow of a fluid in one direction, while allowing relatively unimpeded flow in the opposite direction

**Choke** – A carbureted induction system mechanism which, when actuated, causes an enrichment of the fuel/air mixture to assist cold starting

**Clinch Nut** – A threaded female fastener that has been distorted on one end to supply a gripping force when assembled to a stud or bolt thread

**Clutch** – A device whose function is to permit the driver to engage/disengage a power coupling between the engine and the transmission or transaxle

**CO** – Carbon monoxide

**Cockpit** – The driver/passenger volume within a car in which driver control devices, gauges, and seating are provided

**Cockpit Adjustable** – Any system or component that can be adjusted by the driver while he/she is completely secured in the vehicle with all required safety devices in place and/or while the vehicle is in motion

**Coil** – The transformer component of an ignition system that converts each low voltage pulse into a pulse of sufficiently high voltage to bridge the gap in a spark plug and initiate combustion in the engine

**Coil-Over Shock** – A tubular shock absorber that contains top and bottom mounting locations for a coaxial coil spring and is used with such a spring supporting the weight of the car

**Cold Air Box** – An engine carburetor attachment of unspecified size and composition, whose purpose is to provide a source of ambient air alternate to that existing in the engine compartment

**Component** – A constituent part of an assembly

**Compression Ratio** – Reciprocating engines: the ratio of the sum of swept plus upswept volumes to the unswept volume

**Compression Ring** – A reciprocating engine component that is intended to seal the gap between the piston and cylinder wall against the pressure differential arising from compression, induction or combustion

**Compressor (AC)** – The engine-driven pressurizing pump in an automotive air conditioning system

**Concentric** – Two components or objects are concentric if they share a common centerline.

**Condenser (AC)** – The portion of an automotive air conditioning system in which the refrigerant in vapor phase is converted to liquid phase

**Connecting Rod** – A component physically connecting a piston to a crankshaft in such a way as to convert the rotary motion of the crankshaft to a reciprocating motion of the piston

**Constant-Velocity Joint** – A type of universal joint in which the angular velocities of input and output shafts are held approximately equal

**Cool Suit/Shirt** – Driver comfort clothing that may be cooled by a circulating liquid or frozen inserts

**Cooling System** – Those components directly associated with the cooling of an engine, including any hoses, fans, radiators, etc.

**Cowl Induction** – An arrangement in which the incoming air for an induction system is ducted from the cowl area below the windshield.

**Crank-Triggered Ignition** – An ignition system in which the triggering pulses are obtained from a pickup and wheel connected directly to the crankshaft, or to an intermediate pulley

**Crankshaft** – The rotating engine component which, driven by piston/connecting rod assemblies, transmits, for external coupling, the torque resulting from the combustion process.

**Crown** – The top face of a piston at which combustion takes place

**Curvature** – The dimension defined by the maximum distance between a curving surface and the straight line between its ends

**Cylinder Liner (Sleeve)** – An insert in an engine block that defines the path followed by a piston in its reciprocating motion

**Dashboard** – See **Instrument Panel**

**Decamber** (Verb) – To make the wheel camber more negative

**Deck** – Generally the rearmost upper body panel of a car, but not present in all cars

**Deck Height** – The distance between the top of the piston at its outer edge and the machined surface that forms the head/block interface of the block

**Deck Lid** – The access door into the volume (often “trunk”) beneath a deck

**Differential** – A gear assembly, physically separate from the transmission, whose purpose is to reduce the rotational velocity transmitted from the engine/gearbox, while providing a division of driving force to two wheels

**Differential Housing** – The housing in which the differential (final drive) gears are mounted

**Disc Brake** – A braking system that relies on the friction between a suitable material in the form of a “pad” and a rotating disc to supply the braking force at a wheel

**Discriminator Valve** – A check valve designed to install on the vent line of a fuel cell, allowing vapors to vent while retaining liquid

**Dish** – A concave piston crown

**Displacement (Engine)** – Reciprocating engine: the swept volume of one cylinder times the number of cylinders

**Distributor Cap** – An ignition system distributor component that contains the high voltage distribution contacts and means for securing the high voltage wires

**Dome** – A convex piston crown

**Door Panel** – The trim panel that covers the inner shell of a door

**Dowel** – A tubular or cylindrical pin, the sole purpose of which is to make positive location of two assembled components possible

**Drive Belt** – A continuous flexible reinforced elastomer band that provides the driving force for engine accessories, when attached by pulley to a rotating part of the engine, such as the crankshaft.

**Drive Shaft** – The mechanical drive train coupling between transmission and differential, which may allow an angular displacement of the driving and driven axes by the use of universal, constant velocity, or flex joints

**Drive Train** – Those components in a car that produce and convey the driving power to the ground, and the housings containing these parts

**Dry Break Coupling** – An attachment to an on-board fuel cell/tank filler neck/hose that is designed to prevent the spillage of fuel during refueling operations

**Dry Sump** – An engine lubrication system in which the residual lubricant is pumped to an external storage tank by a “scavenge pump,” and an additional pump or pumps return a supply of pressurized lubricant to the engine from the storage tank

**Dry Tire** – A race tire, often with groove-less tread, intended strictly for use in competition under dry conditions

**Dryer (AC)** – A component of an automotive air conditioning system that is intended to remove water from the refrigerant

**Duct/Ducting** – A tube or passage for conveying a material, usually air

**Dust Shield** – A cover intended to protect disc brake components from mud, dirt, etc.

**Exhaust Gas Recirculation (EGR) Valve** – An engine pollution control device that channels a portion of the exhaust gases back into the combustion regions of the engine

**End Plate** – An air control panel mounted at each end and perpendicular to a wing, intended to maximize the efficiency of the wing by preventing spillage of flowing air at the ends

**Engine** – The primary power plant of a car, including all physically attached ancillary components necessary for power production

**Engine Air Box** – An induction system attachment, generally part of the bodywork, which ducts air from an opening protruding into the air stream to the induction system intake(s)

**Engine Case** – See **Block**

**Engine Compartment** – The loosely defined volume, nominally enclosed by panels on top and sides, which is the normal location of the engine in a car

**Engine Mount** – A passive mechanical coupling used to support the weight of an engine at its attachment points to the structure of a car

**Engine Steady Bar (Torque suppressor)** – A constraining beam or rod intended to resist the tendency of an engine to rotate on its mounts in reaction to torque forces

**Engine Swaps** - An “Engine Swap” occurs when a car receives an engine that is different from the type it contained when delivered from the factory. The engine being installed must have been available from the factory in the US market for the chassis/variant and body style and exterior contour it is being installed into. The converted vehicle must comply ALL specifications of the vehicle to which it is converted including exterior body style

**Evaporator (AC)** – That portion of an automotive air conditioning system in which the transition from liquid phase to vapor phase occurs

**Exhaust Pipe** – A duct of unspecified dimensions, the function of which is to convey exhaust products toward the rear of a car and away from the driver

**Exhaust Port** – The duct within a cylinder head or rotor housing through which the exhaust gases pass from the exhaust valve(s) to the outer flange of the head

**Exhaust System** – A passive system with components that serve to convey the exhaust of an engine past the driver and away from the car

**Expansion Tank** – A container, often operating at system pressures, which is designed to contain engine coolant on expansion at operating temperatures

**Extension** – An external modification resulting in more material on the outside of the component than originally existed

**Fairing** – A covering intended to divert airflow in a specific region of a car, to reduce air drag

**Fan** – A rotating bladed device intended to provide a cooling flow of air to a heat exchanger

**Fan Belt** – A flexible drive belt that is used to drive a water radiator cooling fan, and, often simultaneously, furnish drive to one or more other rotating attachments to the engine

**Fasteners** – Any mechanism that serves no other purposes than to cause a component to maintain a fixed position (i.e. bolt, nut, screw, etc.)

**Fender** – The body panel covering a road wheel assembly

**Fender Flare** – An attachment to an existing fender that extends the fender outward to cover the tire more completely

**Fender Skirt** – A removable fender extension that partially closes the wheel opening, smoothing the air flow in this region

**Filler Cap** – A closure that prevents the loss of fuel from the filler neck/hose when the car is in use, but that may be removed for refueling

**Filler Neck/Hose** – The attachment to a fuel cell/tank through which fuel is supplied from a source external to the car

**Final Drive Housing** – See **Rear Axle Housing**

**Final Drive Ratio** – The ratio of input to output shaft motions in a final drive or differential

**Fire Extinguisher** – An on-board container of specified capacity charged with approved fire extinguishing material that provides the driver or others with the capability to control small fires

**Fire System** – An on-board fire extinguishing system designed to be activated in the event of fire, whose purpose is to extinguish or retard the fire, thus providing a measure of protection for driver and car

**Firewall** – A vertical (plus or minus 10 degrees) metal panel separating and protecting the driver/passenger compartment from the engine compartment, preventing the passage of flame and debris. Metal ducts may penetrate the firewall but must begin and end outside of the driver/passenger compartment. No intakes are allowed in the firewall

**Firing Order** – The order in which the cylinders in a reciprocating engine produce power under normal conditions

**Flare** – (Verb) To extend by extrusion or attachment a fender so as to more completely cover the tire mounted within – (Noun) Extruded end of a pipe or tube

**Flat Bottom** – A race car construction in which the underside of the car is nominally flat and contains no “ground effects” shaping or ducting

**Flex Joint** – A coupling designed to fulfill the function of a universal joint but employing flexible materials to achieve changes in the drive axis

**Float** – A carburetor component which, with an associated valve, controls the fuel level in the reservoir supplying the carburetor jet(s)

**Float Chamber** – The carburetor component that contains the reservoir of fuel supplying the jet(s)

**Float Valve** – The shut off valve actuated by a carburetor float, which controls the maximum level of the fuel in the float chamber

**Floor Pan** – The section(s) of a car normally used as a supporting platform for seats and to physically separate the interior (cockpit) area from the underside of the car

**Fluid** – Any material that readily flows at the specified temperature (for example, liquids and gases at room temperature)

**Flywheel** – An engine attachment whose normal functions are to provide a gear appropriate for starter engagement, to provide a friction drive surface and attachment points for a clutch pressure plate, and to smooth the flow of power

**Fuel** – The chemical mixture which, when mixed with air, is burned in an engine to produce power

**Fuel Cell** – A crash-resistant container for the on-board fuel supply of a car

**Fuel Distribution Unit** – A fuel injection induction system component that accomplishes the distribution of fuel to the injection nozzles

**Fuel Filler Restrictor** – A plate with a small flap designed to restrict refueling to a specifically sized nozzle

**Fuel Injection** – A system, including mechanical and/or electrical components, whose function is to provide fuel, via pressurized nozzles, to the engine in lieu of carburetion

**Fuel Line** – A hose or tube that conveys fuel from one point to another

**Fuel Metering Unit (Fuel Pressure Regulator)** – A component of a fuel injection system which, under external control, determines the quantity of fuel supplied to the engine at any given time

**Fuel Pickup** – The attachment to a fuel tank or fuel cell at which point the supply line(s) leading to the fuel pump(s) are attached

**Fuel Pump** – A pump, mechanical or electromechanical, whose function is to cause the transport of fuel from the fuel cell or tank to the induction system

**Fuel Tank** – A conventional OEM container, not of the safety fuel cell type, for the on-board fuel supply of a car

**Gas Cap** – See **Filler Cap**

**Gasket** – A sealing component of unspecified composition that is intended to prevent the leakage of a fluid (air, water, oil, etc.) at the interface between two demountable assemblies

**Gauges** – Mechanical or electronic readouts of automotive parameters

**Gear** – A toothed drive train component used, in mesh with another gear, for the transmission of rotational force

**Generator** – An engine-driven attachment that produces direct current to replenish an on-board storage battery

**Grille** – The decorative covering for the grille opening

**Grille Opening** – The opening in the front of a car, through which cooling air is ducted to the radiator(s), and in some cases, to other accessories, or to the engine

**Ground Effects** – A term for a car design in which airflow produces a significant pressure differential between the upper and lower portions of the body/chassis, creating downforce on the assembly

**Gudgeon Pin** – English term for piston wrist pin

**Gusset** – A brace generally formed by welding, a plate at or near the junction of two structural beams or tubes, providing reinforcement particularly in the plane including the tubes and the plate

**H.D.** – Heavy duty

**H.T.** – High tension. English term for spark plug voltage in regard to ignition components

**Hand Brake** – A braking system component causing a braking action on one or more wheels, or on another part of the drive train, which may be actuated and locked in the engaged position by the driver

**Hardtop** – A removable rigid substitute for a convertible or roadster top

**Hatchback** – A hinged body component containing the rear window that, in the open position, gives access to the interior of a car from the rear

**Head and Neck Restraint** – A protection device that attaches to the helmet and is intended to decrease neck stresses and forward head movement during an impact

**Head Rest** – See **Head Restraint**

**Head Restraint** – A cushioned, fixed restraining object intended to protect the driver under conditions that cause the driver's head to be thrust rearward

**Header** – A multibranch exhaust system assembly, the function of which is to convey the exhaust products from more than one cylinder to one or more exhaust pipes

**Header Tank** – A component of an engine cooling system, generally at the top or above the radiator, which is often used as the filling point for the system

**Headlight Cover** – A protective cover for headlight(s) that is part of the original configuration of the body design.

**Heat Riser Tube** – An attachment to an induction system that provides a source of warmed air, generally from the exhaust system, as an aid to cold runnin

**Heat Sink** – A part of a system used to convey and dissipate heat from another part of the system

**Helicoil** – A commercial repair for internal threads

**Homologation** – A system whereby the manufacturer/competitor certifies that a Formula or Sports racing car, as produced, complies with the applicable specifications

**Hood** – The panel or assembly of panels that cover the engine compartment

**Horn** – The audible signaling device with which highway cars are equipped

**Hot Terminal** – The terminal of a storage battery that is not connected to the frame or chassis of the car

**Hub** – A component to which a road wheel is attached, which provides support for the wheel, and has the capability, via attached internal bearings to rotate on a fixed shaft

**Hub Caps** – Decorative removable attachments to the central area of road wheels

**Hub Carrier** – A suspension component that provides the means for mounting a rotating wheel hub, and for attachment of suspension components and stabilizers

**Idler Shaft** – A shaft that rotates or supports another component that rotates without itself transmitting the rotational force

**Ignition System** – A system that converts on-board storage battery supply voltage into a timed sequence of high voltage pulses suitable for igniting engine combustion mixtures in a controlled manner

**Independent Suspension** – A suspension system in which either wheel on the referenced end of the car can undergo its normal vertical motions without directly influencing the motions of the other wheel

**Induction System** – Those engine components directly associated with the creation and conveyance of the combustible mixture, and any functional associated attachments thereto

**Injection Nozzle** – The fuel induction system component through which fuel is forced under pressure to form a combustible mixture with air

**Inlet Port** – The cylinder head duct leading to intake valve(s)

**Insert (Strut)** – The replaceable portion of a suspension strut, basically a tubular shock absorber with the necessary fastening element(s) for the upper strut mounting point

**Instrument** – An indicator or readout which, when active, contains information about some aspect of car operation for driver reference

**Instrument Panel** – A panel, the associated mounting bracket(s), and HVAC ducting components, located within the cockpit of a car, and in a position convenient for driver visibility, which may provide a mounting area for various gauges and controls; also referred to as a dash pad or dash panel

**Intake** – An opening through which fluid/air enters an enclosure

**Intercooler** – A heat exchanger associated with a turbocharging or super-charging system, which is intended to reduce the temperature of the incoming air or air/fuel mixture and is located in ducting between the turbo/super-charger and the engine

**IR** – Individual runners (No balance pipe, no plenum)

**Jack Points** – Locations on the underside of a car suitable for the application of a lifting jack

**Jack Shaft** – A shaft that transfers a driving force from one element of an engine to another, such as the drive for an oil pump and/or distributor, taken from an overhead camshaft

**Jet** – A carburetor aperture component which is used to meter air and/or fuel flowing into the mixing region of the carburetor by presenting restriction to the flow

Kill Switch – See **Master Switch**

**L.T.** – Low tension. English term for battery voltage in regard to ignition components

**Limited Slip Differential** – A differential which is designed in such a way as to overcome the normal action of a differential to apply most of the available torque to the least loaded wheel, and instead to apply a significant portion of the torque to the most loaded wheel

**Linkage** – A link or system of links (cables, rods, etc.) that convey a mechanical force from one location to another

**Lip-Type Rear Spoiler** – A directly attached aerodynamic device that generates downforce from the action of air flowing over a single surface, creating a turbulent depression away from the direction of motion

**Lobe Center** – The angular position of a camshaft, defined as that position in the rotation at which the lift of an associated tappet will be greatest

**Locked Differential** – A variation of the limited slip differential in which no relative slippage of the two driven wheels is permitted under any conditions

**Lubricant** – A substance which, when interposed between components moving with respect to each other, reduces friction and promotes durability.

**Luggage Compartment** – The region within the bodywork of a car that is designated as being intended for the carrying of luggage

**“M” Model Components** – Those components specific to M model cars (i.e. M1, M3, M5, M6)

**Magneto** – An ignition system component that generates the electrical power for ignition of combustion with a system of magnets and coils in relative motion

**Main Bearing Cap** – A reciprocating engine component which has provision for nominally half of one main crankshaft bearing, and which, when attached to the engine block, may also provide lateral location for the crankshaft

**Manifold** – A passive device for conveying gases into or out of an engine, generally to achieve the connection of differing numbers of ducts

**Master Cylinder** – A hydraulic component of the braking system that produces positive pressure in the hydraulic lines on the application of mechanical force

**Master Switch** – A safety switch that can be actuated by the driver or other to disable all operating electrical functions, without disconnecting the electrical supply to any fire system present. Also called a kill switch

**McPherson Strut** – (See **Strut Type Suspension**) A front suspension type utilizing a strut with integral tubular shock absorber and coil spring, with the steering swivel axis that of the strut/shock; upper location is by strut only

**Metallic** – A material having iridescent or specular (mirror-like) reflective qualities (for example, aluminum foil)

**Maximum Body Width** – The widest point of the beam of the race car at the front or rear structural quarter panels or doors, including allowed flares. Mirrors or other similar items are not considered part of the body for width determination

**Metering Rod** – A carburetor component that aids in the metering of fuel flow

**Mirror (Rear View)** – A reflective device whose sole purpose is to enable the driver's field of vision to extend in a rearward direction

**Modify** – To change a component by reworking, but not by replacing

**Monocoque** – A frameless construction in which the main structure of a car is composed of a permanent assembly of panels to which the running gear, suspension and body are attached

**Motor Mount** – See **Engine Mount**

**Mudguard** – A partial fender, generally not contiguous with the car body

**Muffler** – A component, the function of which is to reduce the sound level from an exhaust system

**NASCAR-Style Door Bars (Ladder Bars)** – If installed, shall consist of one or more sidebars that intrude into the door cavity and connect the roll cage main hoop to the front hoop

**Needles (Carburetor)** – Tapered carburetor fuel flow metering shafts, or tapered shafts used in float shutoff valves

**Nitride (Verb)** – To heat process ferrous metal components so as to increase the surface hardness

**O-Ring** – A seal or gasket generally made from an elastomer or metal, in the shape of a torus with a circular cross section

**O E (OE)** – Original Equipment. Original or factory-installed standard or optional equipment and components available on standard production vehicles delivered to BMW or MINI authorized dealers for sale to the general public for use on public roads

**O E M (OEM)** – Original Equipment Manufacturer. OEM status (in the United States) signifies that BMW's automotive products have been tested and validated according to Federal Motor Vehicle Safety Standard (FMVSS) and Department of Transportation (DOT) regulations. OEM may also describe parts manufactured by companies that supply BMW with components used to build vehicles, but not necessarily that same part that BMW actually uses to build vehicles.

**Offset Key** – A metal drive key for coupling a shaft and a pulley, wheel, or sprocket, in which opposite radial ends of the key are offset to achieve adjustment of the phase relationship of the driving and driven parts

**OHC (Overhead Cam)** – A type of reciprocating engine in which the camshaft(s) are located in the cylinder head(s), and act on the valves, either directly or through a linkage.

**Oil Filter** – An engine accessory intended to intercept all or a portion of the lubricant circulating from the oil pump, and to remove, by trapping, solid particles from the lubricant

**Oil Galley** – A passage within an engine block that carries the flowing lubricant to various internal distribution points

**Oil Line** – A hose or pipe, external to the engine, which conveys lubricating oil from one point to another

**Oil Pan** – An oil sump fixed to the bottom of an engine

**Oil Passage** – A duct within an engine component intended to convey lubricating oil

**Oil Pump** – A mechanically driven pump designed to draw lubricant from a reservoir, or sump, and supply it under pressure to the balance of the lubrication system

**Oil Strainer** – A screen surrounding the oil pickup in an engine that is intended to keep relatively large solid particles from being drawn into the pump

**Oil Sump** – The container in which the return lubricant from the engine is collected to form the supply from which the pump may draw

**Outline** – A line that marks the outer limits of an object or figure

**Overhang** – The distance that the end of the bodywork extends away from the wheels at the referenced end of the car

**Parkerizing** – A commercial process in which a metal part, usually a camshaft, is treated to increase resistance to break-in scuffing

**Parking Brake** – See **Hand Brake**

**Parking Light** – A non-racing lighting component, frequently combined with lighting components of other functions, intended to illuminate the extremities of a car while parked

**Phase** – The angular relationship between two rotating components, or between one rotating component and a periodic event

**Pickup point (Suspension)** – The location of attachment of a suspension component on the sub-frame, or structure (unibody) of the car. Pickup point is also referred to as “pivot axis”

**Pilot Bearing** – A bearing, generally within one end of a shaft, which is intended to support another shaft under conditions of relative rotary motion

**Piston** – A reciprocating engine component whose functions are to provide a partial vacuum with which to induce the flow of fuel/air into the combustion region, to convert the combustion pressures to reciprocating motion, and to expel exhaust gases

**Piston Ring** – A reciprocating engine component which, when mounted on a piston, provides either sealing or oil control functions when the engine is in operation

**Pitman Arm** – A steering system component that translates the rotation of the steering gears to a linear motion of steering links

**Plenum** – An induction system chamber generally interposed between carburetor(s) or air intake(s) and ducts feeding ports

**Points (Ignition)** – The switch portion of a distributor actuated by cam lobes, which interrupts the current flowing through the primary windings of an ignition coil, thus generating high voltage pulses that are conveyed to the spark plug

**Polish (Verb)** – To reduce the roughness of a surface by mechanical, chemical, or electrochemical means

**Port** – See **Intake, Exhaust Ports**

**Power Brakes** – A braking system in which the driver-initiated mechanical force acting on a master cylinder is assisted by a servo mechanism, generally derived from manifold vacuum

**Power Steering** – A steering system in which the driver-initiated force acting on the steering gears is assisted by a servo mechanism, usually involving an engine-driven hydraulic pump

**Pressure Equalizing Device** – A braking system component intended to equalize or allow adjustment of the relative pressures in separate branches of the hydraulic system (for example, front/rear)

**Pressure Plate** – The clutch assembly component that provides the force necessary to couple the engine to the next component in the drive train through friction surfaces

**Pressure Regulator Spring** – A spring whose installed force determines the pressure at which a valve or valve system will open to allow the flow of fluid

**Profile (Verb)** – To measure or to reshape the contour of a camshaft lobe, rocker arm or similar component

**Propeller Shaft** – See **Drive Shaft**

**Proportioning Valve** – A braking system component intended to allow adjustment of the hydraulic pressures available in separate branches of the system (for example, front/rear)

**Pulley** – A rotational attachment for a drive belt

**Qualifier** – (a) One who receives a time, or (b) One who is waived into a race by the Competition Steward and starts the race

**Racers Tape** – Generally duct tape, an adhesive, fabric-backed tape

**Rack and Pinion** – A type of steering system, or the gear components thereof, in which the rotary motions of a pinion gear attached to the steering shaft act on a rack, or linear gear

**Radiator (Cooler)** – A heat exchanger intended to remove heat from engine or gear fluids

**Radius (Verb)** – To contour an abrupt edge on a component by increasing the radius of the transition

**Rain Tire** – A racing tire intended solely for competition in wet conditions

**Ram Air** – A type of induction system in which the incoming air is obtained from an extension into the air stream outside the bodywork

**Ratio (Gear)** – The number of rotations of the drive shaft that produces one rotation of the driven shaft(s)

**Rebound** – A suspension term referring to motion in the upward direction

**Reciprocating Engine** – An internal combustion engine in which the driven actions of one or more pistons are converted to the rotary motion of a crankshaft

**Relief Valve** – A check valve intended to vent at a predetermined pressure differential

**Remote Reservoir Shock Absorber** – Any shock absorber or damping device that uses an externally mounted (connected either by hose or “piggyback” design) fluid and/or gas reservoir

**Repair (Verb)** – To remove the effect(s) of accidental damage to a component, returning it to original or legally modified dimensions and function

**Replica** – A component identical to or very similar in appearance and function to the original that it replaces

**Resistor Spark Plug** – An ignition system spark plug containing electrical resistance that is intended to reduce radio interference

**Ride Height** – The distance from level ground to the specified portion of the car, with the tires, wheels, air pressure, etc., as normally raced

**Rim Width** – The distance between the opposing lateral sides of a road wheel in the region where the bead of a tire seats. Measuring method per tire and rim association standard

**Ring Gear** – The main driven gear in a final drive assembly, driven by a pinion gear. Also, the starter engagement gear on a flywheel

**Rocker Arm** – A valve train component that transfers the motions of the camshaft, often with a multiplication of travel, to a valve

**Rocker Cover** – See **Valve Cover**

**Rocker Panel** – The body panel closest to the ground extending along either outer side of a car between the wheels

**Rod End** – A load-bearing threaded mechanical coupling with angular freedom of the relative axes and that allows rotation of the inner portion with respect to the outer, (for example, heim joint)

**Roll Bar** – A safety device designed to protect the driver from injury in the event of a roll-over accident

**Roll Cage** – An extension of a minimal roll bar, designed to protect the driver from injury from accidental forces in several directions

**Roller Cam Follower** – An engine component (tappet) that utilizes a rolling member to contact the camshaft

**Runner** – A duct of an induction system leading to the cylinder head

**Running Light** – A signaling light of specified size and location, which can be activated by driver control, and is intended to improve the ability of other drivers to detect the signaling car

**Scatter shield** – A stationary safety device intended to protect the driver in the event of catastrophic clutch/flywheel failure

**Scraper** – A passive internal attachment to an oil pan whose purpose is to control the return flow of lubricant by removing it from the rotating crankshaft

**Seal** – A conformable sealing component generally used to inhibit the passage of fluids along the shafts of moving parts, such as valves, master cylinders, etc.

**Seat Belt** – A safety strap, generally containing the attachment/release mechanism for all other safety straps, intended to restrain the driver against forces tending to move the driver

**Section Width** – The lateral cross section of a tire, sidewall to sidewall

**Servo Assist** – The application of mechanical assistance, through vacuum or hydraulic or other external action, to reduce the forces required from the driver

**Shaved Tread** – A tire tread that has been abraded or cut to reduce the tread depth

**Shift Fork** – A transmission or transaxle component that directly moves gears into engagement or disengagement in response to driver actions

**Shock Absorber** – A device intended to damp the actions of road springs

**Shot Blasting** – See **Shot/Glass Peening**

**Shot/Glass Peening** – A treatment, consisting of impelling small glass or metal balls into metal parts, intended to reduce stresses in components

**Shoulder Harness** – A safety strap assembly intended to restrain the driver's upper body under conditions of rapid reduction of forward velocity

**Side Marker Light** – A small light fixture normally mounted on the side of a fender, which is intended to make the car more readily visible from the side under appropriate conditions

**Signal Light** – A light fixture used to signal turns or, in some cases, stops

**Slave Cylinder** – A hydraulic system component that achieves the conversion of hydraulic pressure to mechanical force, usually to accomplish a disengagement of the clutch

**Spark Plug** – An engine component which, by means of high voltage supplied by an ignition system, initiates the combustion of the air/fuel mixture

**Specification** – A detailed presentation of parameters that determine the performance or suitability of a system or assembly of systems to accomplish design goals

**Spherical Bearing** – A load-bearing connector in which the central portion is convex and the outer portion is concave, allowing both angular displacements of the axes and relative rotation

**Spider Gears** – Components of the torque division section of a conventional differential gear assembly

**Spindle (Stub Axle)** – The shaft, and integral assembly supporting a wheel hub, and often, braking and/or steering components

**Splitter** – An aerodynamic piece that is parallel to the ground and attaches to the bottom of the front bumper cover or air dam

**Spoiler** – A panel attached to the body of a car at the front, intended to alter the airflow around or under that end of the car when in motion

**Spring Cap** – See **Valve Spring Retainer**

**Spring Shock** – A suspension assembly containing a coil spring surrounding a tubular shock absorber

**Spring Washer** – A spacer designed to exert force against securing pressure, thus reducing the tendency of an attached threaded fastener to separate

**Sprocket** – A gear made specifically for use with a drive chain

**Stabilizer** – An attachment to the suspension system, not usually part of the suspension, which aids in maintaining the relative alignment of a wheel or wheels to the car

**Starter (Self Starter)** – An electrical device that is used to initiate normal engine operation by converting electrical energy into mechanical rotation of the engine

**Starter Ring** – The gear on the outer periphery of a flywheel for application of drive from a starter

**Stay rod (cross or X brace)** – A rigid reinforcement bar or rod interconnecting opposite sides of a car at structurally significant locations

**Steering Arm** – The rigid link in a steering system that conveys the steering action from the steering gears and linkage to a wheel assembly.

**Steering Column** – The shaft forming the connection between the steering wheel and the steering gear, through which driver-initiated steering motions are transmitted

**Steering Linkage** – The various components, exclusive of gears, steering column and steering wheel, which transmit the driver's steering motions to the steered wheels

**Steering Lock** – The degree of turning motion given to the steering wheel, and hence to the steered wheels. "Full lock" denotes the maximum available turning angle.

**Steering Lock Mechanism** – An antitheft device used to lock the steering shaft or wheel when the ignition key is withdrawn

**Stock** – Referring to a component on the car that is as delivered on the vehicle through the regular U.S. dealer network

**Stock Replacement** – Referring to a component on the car that is as delivered on the vehicle through the regular U.S. dealer network but is replaceable by either the OE- or OEM-equivalent component

**Streamlining** – Smoothing the airflow over a portion of the car

**Stroke** – The length of travel of an engine piston from uppermost to lowermost positions

**Strut (Stabilizer)** – A rigid beam used to assist in the location of suspension components

**Strut Type Suspension** – Strut suspension consists of three pivoting attachment points including a single upper attachment point, the spindle being mounted on a telescoping post with no vertical movement at the top attachment point

**Stub Axle** – See **Spindle**

**Surround** – To enclose on all sides

**Sunroof** – A movable panel in the roof of a car, which may normally be partially opened from within the car

**Supercharger** – An induction system compressor component, mechanically driven from the engine, which provides forced flow of the fuel/air mixture into the engine by the generation of positive pressure

**Suspension Bushing** – A hollow cylindrical mounting component that acts as a bearing, allowing constrained motion, between a suspension component and attachment point

**Suspension Control Arm** – A beam or frame intended to limit the normal motion of the affected suspension part to predetermined paths

**Swaged Fitting** – Tubing fitting that utilizes some form of extrusion of the tubing to form a seal against the leakage of pressurized fluid from within the tubing

**Sway Bar** – See **Anti Roll Bar**

**Synchronizer** – A transmission component that aids in matching speeds of two gears as they are engaged

**System** – An assembly of components with an identifiable primary function.

**Taillight** – The running (parking) light assemblies at the rear of a car, which may include lights with stop and/or turn signaling functions

**Tap (Verb)** – To cut threads in a hole to retain a stud or bolt with threads of matching pitch and diameter

**Tappet** – (Cam follower, valve lifter) An engine component which, in contact with the camshaft, follows its rotating profile, resulting in a programmed reciprocating motion suitable for actuating valves

**T D C** – Top dead center, referring to the rotational position of the crankshaft when the number one piston is farthest from the crankshaft

**Thermostat** – An engine cooling system regulator device that is intended to control the temperature of the coolant by modulating the flow through an aperture

**Throttle Butterfly** – An induction system component that may effectively vary the area of the induction port when turned (in response to driver input) from parallel to the flow in the port (“full throttle”), to almost perpendicular to the flow (“closed throttle”).

**Throw-out Bearing** – A bearing which, in response to driver actuation, accomplishes the application of the force needed to release the friction clutch through the actuation of the pressure plate

**Tie Rod** – The link connecting a portion of the steering system that is fixed to the chassis to a sprung wheel

**Time (Verb)** – To adjust the phase relationship of ignition and crankshaft, or of camshaft(s) and crankshaft.

**Timing Belt** – A toothed belt used, with appropriate pulleys, to convey drive force in a synchronous manner from the crankshaft to one or more camshafts.

**Timing Gear** – The engine gear or sprocket attached to a camshaft and driven by the crankshaft via gear(s) or chain.

**Tire Tread** – The portion of a tire containing the material intended to be in road contact while a car is in straight-ahead motion.

**Toe (-In, -Out)** – The measure of the position of the wheels on either axle of a car with respect to each other, with reference to the fore/aft direction.

**Top (Removable)** – A removable covering for an open car, normally supplied for protection against the elements

**Torque Biasing Differential** – A form of limited slip differential

**Torque Converter** – An engine-driven power transmission device that couples driving and driven shafts with a variable speed reduction

**Torque Suppressor** – See **Engine Steady Bar**

**Track** – The distance between the center of the rims of two wheels at one end of a car, with any angular adjustments at normal settings and steered wheels in the straight ahead position

**Trailing Arm** – A wheel control linkage locating the wheel in the fore/aft direction, which is attached to the car structure at the forward end of the arm, and to the wheel carrier at the rear of the arm

**Transistor Ignition** – A system of ignition in which electronic components are utilized

**Translucent** – Permitting the passage of a reasonable amount of visible light. In the case of fluid containers, permitting the visual assessment of fluid levels by observing these through the container

**Transmission (Gearbox)** – An assembly of driver-selectable gears in an independent housing, located between the engine and driven wheels, whose function is to alter the rotational velocity reaching the wheels

**Transparent** – Offering very little resistance to the passage of visible light, suitable for use in the line of sight

**Trim** – Coverings or attachments whose function is solely cosmetic

**Trued Tread** – The tread of a tire that has been cut after mounting on a wheel so as to ensure that the surface of the tread is equidistant from the center of the wheel at all angles of rotation

**Trunk Area** – The spare tire and/or luggage region inside the body of a car

**Tub** – The central contiguous assembly of stressed panels that form the basic structure of a frameless car

**Tub-based (non-tube - frame) Car** – A non-tube frame car has a stock floor pan, firewall, door pillars, sills, windshields conforming to stock profile, and window frames, etc.

**Tube Frame Car** – A car intended solely for racing, whose main structure or frame is fabricated from an assembly of tubes welded into the desired configuration

**Tuftriding** – A commercial surface hardening process for ferrous metals

**Turbo Boost Control** – An adjustment that causes a change in the degree of turbo boost available.

**Turbocharger** – An induction system compressor component, driven by exhaust gases from the engine, which provides forced flow of the fuel/air mixture into the engine by means of positive pressure

**Undertray (Belly Pan)** – An attachment to the underside of a car intended to smooth airflow and/or to offer driver protection in this region of the car

**Unibody** – A type of construction in which the main car structure is fabricated from an assembly of panels and reinforcements, permanently fastened together, generally by welding, into a single unit

**Universal Joint** – A mechanical drive train component that permits a change in direction of the axis of rotation conveying the force

**Unswept Volume** – The enclosed volume existing in a cylinder/cylinder head with the piston at its closest approach to the cylinder head

**Vacuum Advance Mechanism** – An ignition distributor mechanism which, under the influence of manifold vacuum, changes the ignition timing in a prescribed fashion

**Valve** – A reciprocating engine component, consisting of head and a stem, which may be opened or sealed in phase with crankshaft rotation, so as to control the induction of fuel/air mixtures or the exhaust of products of the combustion process

**Valve Cover** – A cylinder head attachment whose function is to contain lubricants and to protect the valve actuation mechanism from outside contaminants

**Valve Guide** – A sleeve bearing whose function is to provide axial location of a valve, while allowing normal reciprocating motions

**Valve Head** – the portion of the valve that is larger than the stem

**Valve Keeper** – The component, generally two-piece, which secures the valve spring retainer to the valve stem in a cylinder head

**Valve Relief** – A cutout in a piston crown to allow close approach of a valve

**Valve Seat** – The area in a cylinder head in which the head of a valve under spring pressure forms a gas seal

**Valve Size** – The diameter of the head of a valve.

**Valve Spring Retainer (Collar)** – A valve train component that serves the dual purpose of containing the outer end of the valve spring(s), and, by means of valve keepers, connecting the valve stem to the spring

**Valve Spring Shim** – A valve train component whose purpose is to allow the adjustment of the seated valve spring pressure by effectively changing its seated length

**Valve Stem (Engine)** – The shaft portion of a reciprocating engine poppet valve

**Valve Stem (Wheel)** – The attachment to a road wheel through which pressurizing air is admitted/released

**Vapor Lock** – A condition in the fuel delivery system caused by the existence of vapors, rather than liquid fuel, in the fuel pump, resulting in abnormal fuel delivery

**Variable Ratio Drive** – A power transmission device in which at fixed input shaft rotational velocity the rotational velocity of the driven shaft is continuously variable over a prescribed range of ratios

**Velocity Stack (Air Horn/Trumpet)** – An induction system attachment, generally in the form of a cylindrical flare, used to alter the dynamic coupling between carburetor and the mass of incoming air

**Vent** – An aperture that allows pressure equalization between a semi-sealed volume and the outside of this volume by providing a flow path for gases

**Ventilation** – Cooling a component by an intentional flow of air or modifying a component so as to facilitate this process

**Venturi** – A region of constriction in an air duct of a carburetor in which, through the actions of incoming air flow, a reduced pressure is created to induce the inflow of fuel through one or more jets

**Vibration Damper** – Generally a rubber-mounted rotating circular disc or pulley whose function is to reduce the amplitude of vibrations in the mechanism or part to which it is attached

**Visible** – Capable of being seen, perceptible to the eye, apparent, evident

**Voltage Regulator** – An electronic or electromechanical device intended to regulate the charging actions of an alternator or generator

**WAR – Whinny Ass Racer** – A term affectionately used by the National Timing and Scoring Steward and applied to a Racer who is complaining about trivial things.

**Wave Washer** – A thin, continuous spring washer

**Welding** – The process of fusing one or more components into a single unit by means other than adhesives or fasteners (for example, TIG, MIG, soldering, brazing, etc.)

**Wheel** – Flange and Rim

**Wheel (Steering)** – The cockpit-mounted control device, normally circular, which allows the driver to exert manual force with which to control the car's direction of motion

**Wheel Cover** – A removable decorative covering for a road wheel

**Wheel Cylinder** – A hydraulic component of the braking system, which produces mechanical force at the wheel brakes in response to positive hydraulic pressure

**Wheel Fan** – An integral part of or attachment to a wheel assembly with blade- like elements, intended to improve brake cooling

**Wheel Spacer** – A plate of unspecified thickness or material that is mounted between a road wheel and hub to increase the distance from the inside of the wheel to the hub, thereby increasing track

**Wheel Trim Rings** – Decorative removable attachments to road wheels effectively covering the rim area of the wheels

**Wheel Well** – The volume under a fender.

**Wheelbase** – The distance between the front and rear axle centerlines of a car, with the front wheels in the straight-ahead position.

**Windage Tray** – An internal baffle attachment to an engine oil pan that is intended to help maintain a sufficient supply of lubricant at the location of the oil pickup under cornering, braking or acceleration

**Windows:**

**Door or Side** – The opening where the window normally is raised or lowered in a door. Does not include a “vent” window whether fixed or movable

**Quarter (1/4)** – On a 2-door or 4-door vehicle, the window to the rear of the rearmost door. Such windows are not generally raised or lowered, but they may be hinged and open to the rear. Quarter windows are not “rear” windows.

**Rear** – Rear windows are positioned (roughly) at right angles to the longitudinal axis of the car

**Windshield (Windscreen)** – A forward-facing attachment to the bodywork of a car intended to divert the flow of air from forward motion without obstructing forward vision

**Windshield Pillar** – A body component that extends nominally upward from the cowl area, forming one supporting attachment for the windshield

**Wing** – An aerodynamic attachment that is usually attached to the rear deck lid specifically intended to generate downforce from the action of air flowing over the upper and lower surfaces, creating a pressure differential

**Wiring Harness** – Bundles of electrical wires that provide the electrical links in a car

**Wishbone Type Suspension** – A form of suspension in which the lower (and often upper) locating links are in the form of a wishbone or “A-frame” and provide the lateral and at least a portion of the fore/aft wheel location

**Worm and Sector** – A steering gear type in which the steering forces from the driver are transmitted to the steering linkage via a worm gear and a sector gear in mesh

**Wrist Pin** – The one-piece physical link between a connecting rod and a piston